

Rugged Tablet PC R8 User Manual



Table of Contents

BEFORE YOU START	5
PACKAGE CONTENTS	5
PRODUCT OVERVIEW	6
<i>Front View</i>	6
<i>Back View</i>	7
<i>Right View</i>	8
<i>Left View</i>	9
<i>Top View</i>	9
<i>Bottom View</i>	11
STATUS INDICATORS	11
GETTING STARTED	12
INSTALLING THE BATTERY.....	12
<i>Charging the Battery</i>	13
<i>When to replace the Battery Pack</i>	13
<i>Removing the Battery</i>	13
HOW TO USE SWAPPABLE BATTERY (FOR SELECTED MODEL)	14
CONNECTING THE POWER	15
<i>Connecting the Adapter</i>	15
<i>Using Battery Power</i>	16
<i>Configuring the Power Settings</i>	17
STARTING YOUR TABLET PC.....	18
<i>Turning On Your Device</i>	18
<i>Turning Off Your Device</i>	18
OPERATING YOUR TABLET PC.....	19
USING THE QUICK MENU	19
<i>Quick Menu Overview</i>	19
<i>Viewing the Version Information</i>	20
<i>Viewing the Battery Charge Cycles</i>	20
<i>Battery Charging Protection Setting</i>	20
<i>Configuring the Programmable Button (P)</i>	21
<i>Configuring the Up/Down Button</i>	22
<i>Configuring the Touchscreen Settings</i>	22
<i>Assigning an Application to the P Button</i>	23
<i>Accessing the Mobility Center</i>	24
USING THE CAMERA	25
<i>Opening the Camera App</i>	25
<i>Taking Photos</i>	27
<i>Recording Videos</i>	28
<i>Setting a Flash Mode</i>	29
<i>Setting Photo Timer</i>	29

<i>Switching Between Modes</i>	29
<i>Adjusting Focus</i>	30
<i>Adjusting Brightness</i>	31
<i>Configuring Camera Settings</i>	32
<i>Viewing Photos/Videos</i>	34

MAKING CONNECTIONS 35

INSTALLING THE MICROSD MEMORY CARD	35
INSTALLING THE SIM CARD	35
CONNECTING THE MICROPHONE/HEADSET	36
INSTALLING THE PEN HOLDER	37
CONNECTING USB DEVICES	38
CONNECTING TO WIRELESS CONNECTIONS	40

USING THE BIOS SETUP UTILITY 46

BIOS SETUP MENU	46
MAIN MENU	47
ADVANCED MENU	48
BOOT MENU	49
SECURITY MENU	50
SAVE & EXIT MENU	51

MAINTAINING AND CARING FOR YOUR TABLET PC..... 52

PROTECTING YOUR TABLET PC	52
STORING AND HANDLING YOUR TABLET PC	52
CLEANING YOUR TABLET PC	56
TRAVELING WITH YOUR TABLET PC.....	57

TROUBLESHOOTING..... 58

PRELIMINARY CHECKLIST	58
SOLVING COMMON PROBLEMS	58
DISPLAY PROBLEMS	60
HARD DISK PROBLEMS	60
OTHER PROBLEMS	63

APPENDIX 64

COPYRIGHT	64
SPECIFICATIONS	64
REGULATORY STATEMENT	67
<i>Federal Communications Commission Statement</i>	67
<i>Declaration of Conformity</i>	68
<i>European Union CE Regulations</i>	69
<i>RF exposure warning</i>	71
<i>IC Regulations</i>	71

<i>Canada, Industry Canada (IC) Notices</i>	72
<i>EU RoHS</i>	73
<i>REACH - Substances of Very High Concern (SVHC)</i>	73
<i>VCCI</i>	74
<i>Cybersecurity Information</i>	74
<i>Battery Statement</i>	74
<i>Battery Disposal</i>	75
<i>WARNING EXPLOSION HAZARD</i>	75
<i>CLASS 2 LASER PRODUCT</i>	76
SAFETY INSTRUCTIONS	77
SHOPFLOOR DATE CODE FORMAT DESCRIPTION	79

Before You Start

Congratulations on your purchase of this tablet PC.

This rugged tablet PC is portable and provides users with maximum mobile computing experience in a wide range of working environments. Before you begin using your tablet PC, read this chapter to familiarize yourself with the main components installed in the system.

Package Contents

If any of following items is damaged, please contact your retailer.



Tablet PC



AC adapter



Power cord



Stylus and tether



Pen holder with screws



NOTE

- The pictures are for reference only, actual items may slightly differ.

Product Overview

Front View



No.	Item	Description
1	Ambient light sensor	Use to detect the current level of visible light in the surrounding environment.
2	Microphones	Record the surrounding sound.
3	Front camera indicator	Illuminates when the front camera is in use.
4	Front camera	Use for video conference.

Back View

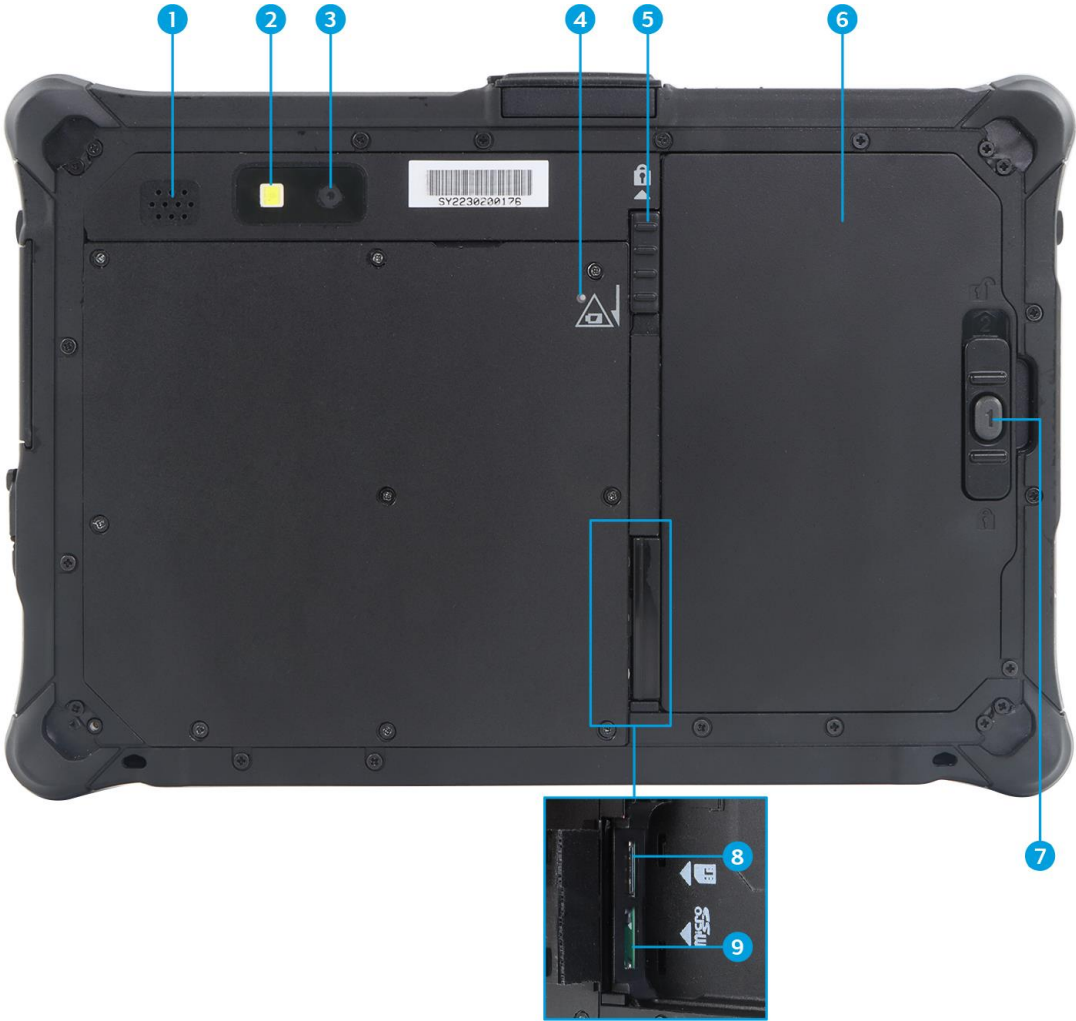

No.	Item	Description
1	Speaker	Emit sound.
2	Camera light	Provide additional lighting when taking pictures under low light environment.
3	Rear camera	Use to take pictures.
4	Battery swappable indicator (for selected models with super capacity support)	If your rugged PC supports super capacity, then swap the battery only when this indicator is illuminated.
5	Battery lock switch	Slide to lock or unlock the battery pack.
6	Battery Pack	Battery Pack.
7	Battery latch release button	Press and hold the button to slide the battery latch to the unlock position.

Before You Start

No.	Item	Description
8	SIM card slot	Use to insert a SIM card for WWAN module connection.
9	MicroSD memory card slot	Use to insert a MicroSD card to transfer pictures, music, and data between your tablet PC and flash compatible devices.

Right View

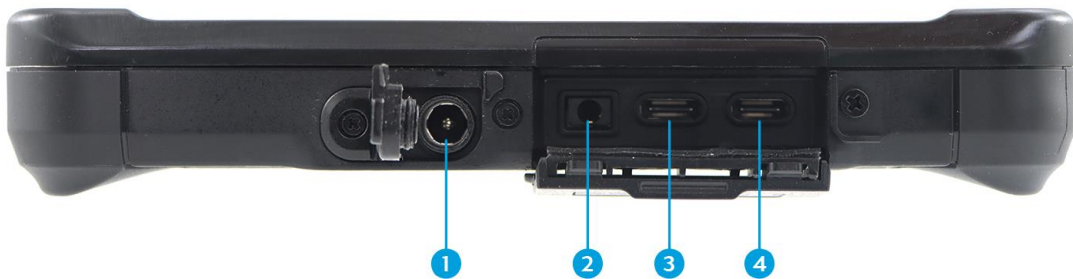

No.	Item	Description
1	DC-IN jack	Connect the power adapter.
2	Audio combo jack	Connect a headphone or an external speaker or microphone.
3	Thunderbolt 4 port	Connect Thunderbolt peripheral devices.
4	USB Type-C port	Connect USB-C peripheral devices. This port also supports DisplayPort function.

Left View



No.	Item	Description
1	Mounting slot	Connect the MSR key or attach the pen holder.

Top View



No.	Item	Description
1	Program button (P)	The button function can be assigned via Quick Menu. <ul style="list-style-type: none">• If the barcode reader is embedded in the system, press to trigger the Barcode scan function (by default).• If the barcode reader is not embedded in the system, press to enable the Stealth mode or other program assigned via Quick Menu.
2	Up/Down buttons	The button function can be assigned via Quick Menu. <ul style="list-style-type: none">• Brightness adjustment: Press to adjust the brightness level.• Volume adjustment: Press to adjust the volume level.• Disable

Before You Start

No.	Item	Description
3	Power button	Press to turn your tablet PC on/off or enter/exit the modern standby (advanced sleep) mode. (Power button settings can be configured in the Start > Settings > System > Power & sleep > Additional Power Settings > Choose what the power buttons do menu).
4	Barcode scanner (for selected models)/ USB 3.2 port (for selected models)	Barcode scanner: <ul style="list-style-type: none">• Scan barcodes. USB 3.2 port: <ul style="list-style-type: none">• Connect USB-A peripheral devices.



NOTE

- When using the tablet PC without attaching an external keyboard, the three-finger salute (Ctrl+Alt+Del) function is defined by pressing the **P-Key** if the **P** button has been assigned to function as the "SAS key" in the Quick Menu. Pressing the **P** button will switch to Windows Security screen, which lets you lock the device, switch to different user, sign out, change a password, enter Task Manager, connect to an available wireless/cellular network, activate the airplane mode, open the Accessibility menu, shutdown/restart the device, or activate the Sleep mode.

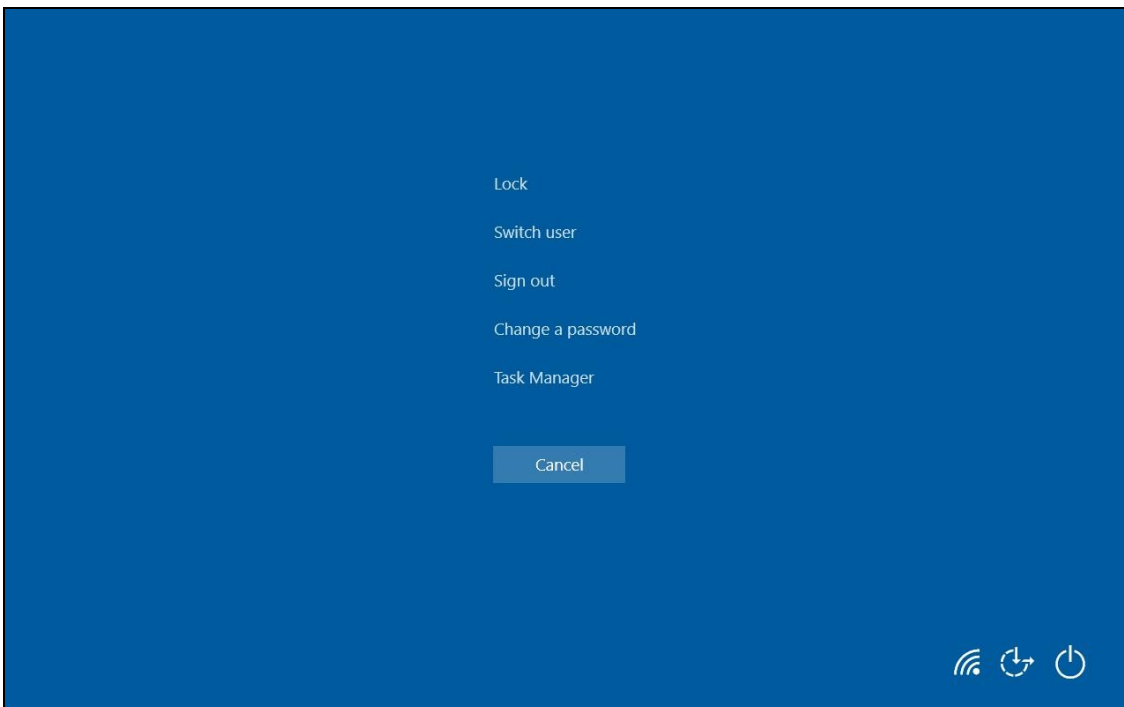

Bottom View





No.	Item	Description
1	RF Pass-thru connectors (optional)	Use for the external antenna of WWAN, GPS, and WLAN.
2	Docking connector	Connect the tablet PC to a docking station.

Status Indicators

The status indicators in the upper side of the tablet PC light up when a particular function of the tablet PC is active.



Icon	Item	Description
	Power	Green LED always lights on when the system is running. When the system is off or in hibernation mode, the LED is off.
	Battery	Indicate the battery status: <ul style="list-style-type: none"> • Green: when battery is fully charged (95% or above) • Orange: when battery is charging • Flashing Orange: when there is a battery error (cannot fully charge the battery within 8h in Regular Mode) • Red: when battery capacity is lower than 7% • Off: when discharged



NOTE

- When the Stealth mode is on then all LED lights will automatically turn off.

Getting Started

This chapter will help you get started using the device.

Installing the Battery

To install the battery, follow the steps below:

1. Align and insert the battery to the battery compartment.
2. Push completely until the battery locks into place.



3. Slide the battery latch to the lock position to secure the battery.



4. Slide the battery lock switch to the lock position.



Charging the Battery

The Lithium-ion battery is not fully-charged upon purchase.

To charge the battery, follow the steps below:

1. Install the battery to your tablet PC. See procedures above.
2. Connect the AC adapter to the DC-IN jack of your tablet PC.
3. Connect the AC adapter to the power cord.
4. Plug the power cord to an electrical outlet.

When to replace the Battery Pack

The battery performance gradually decreases over time and usage.

We recommend you replace your battery pack after 18 to 24 months of usage.

Removing the Battery

To remove the battery, follow the steps below:

1. Slide the battery lock switch to the unlock position.
2. Press and hold the battery latch release button to slide the battery latch to the unlock position.



Getting Started

3. Remove the battery out of the battery compartment.



How to use Swappable Battery (For selected model)



NOTE

- The instructions in this section apply only to the tablet PCs that support the super capacitor function.

To swap the battery, follow the steps below:

1. While the system is in active mode, slide the battery lock switch to the unlock position.
The system will enter the standby mode after 20~30 seconds and the Battery Swappable indicator will turn on.
2. Swap the battery. Then slide the battery lock switch back to the lock position.
The system will reboot and resume to the previous operating stage.



Connecting the Power

Your tablet PC can be powered up using the AC adapter, PD adapter, or the Li-Ion battery.

Connecting the Adapter

Your tablet PC supports both AC adapter and PD adapter. The adapter powers up your tablet PC and charges the battery.

AC Adapter (Barrel-Type)



1. Connect the AC adapter to the DC-IN jack of your tablet PC.
2. Connect the AC adapter to the power cord.
3. Plug the power cord to an electrical outlet.

PD Adapter (USB-C Type)



1. Connect the PD adapter to the Thunderbolt 4 port of your tablet PC.
2. Plug the PD adapter to an electrical outlet.



NOTE

- Ensure that the power output of the PD adapter is at least 65W or above.
- PD adapter is not included in the package.

Using Battery Power

1. Install a charged battery in the battery compartment.
2. Remove the AC adapter (if plugged). Your tablet PC will automatically use the battery power.



NOTE

- If your tablet PC is connected to an electrical outlet and the battery is installed, your tablet PC uses power from the electrical outlet.

Configuring the Power Settings

1. Right-click the battery icon (🔋) on the system tray. Then select **Power Options**.

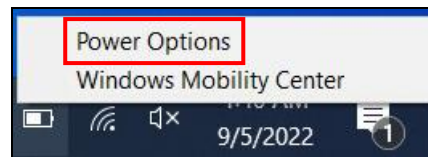

2. Select **Change plan settings** to customize a power plan.

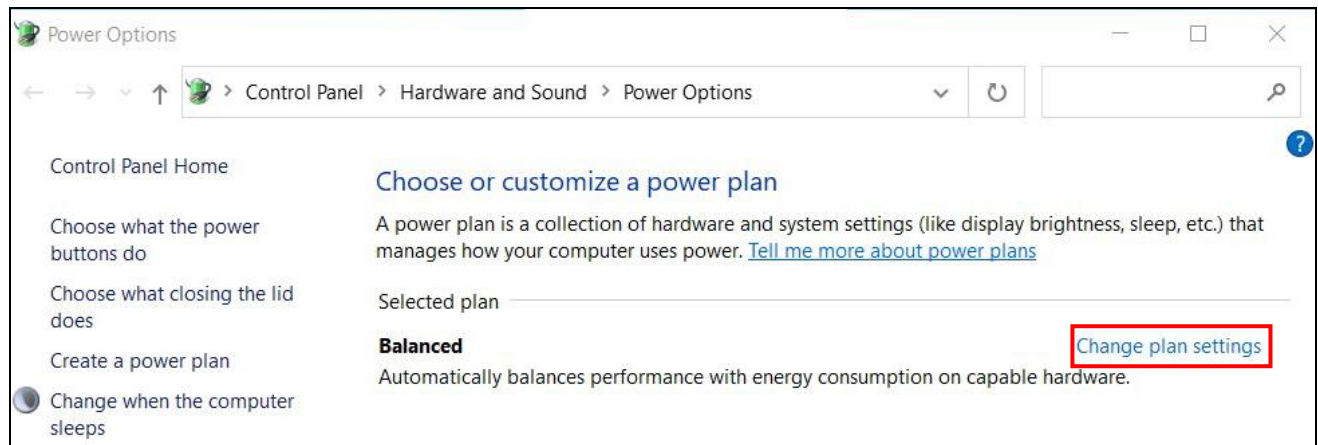

3. Change the desired sleep and display settings. Then select **Save changes**.

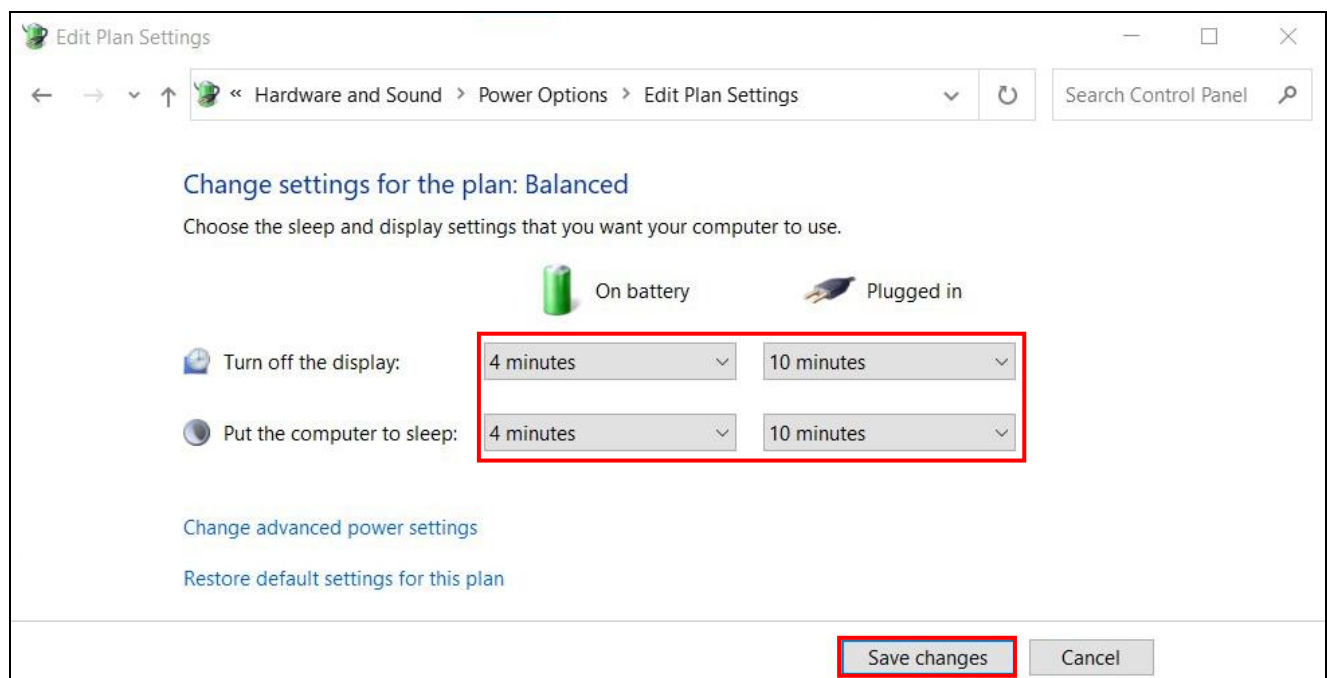

Starting Your Tablet PC

Turning On Your Device

Press the  button until the Power LED lights up.

Turning Off Your Device

It is important to properly shut down your tablet PC to avoid the loss of unsaved data. To shut down your tablet PC, do the following:

Tap  > **Power** > **Shut down**.

Wait for your notebook to turn off power completely before removing the power source (if necessary).

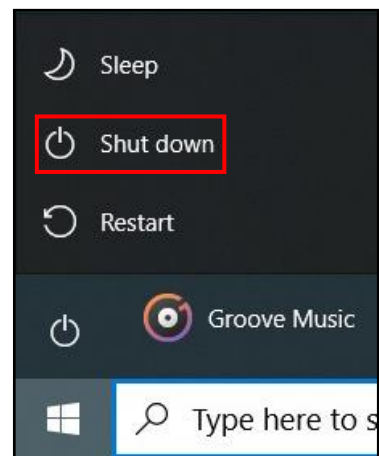

Operating Your Tablet PC

This chapter will guide you on how to use your tablet PC.

Using the Quick Menu

To enter the Quick Menu, tap the arrow on the task bar to display hidden icons. Then tap the Quick Menu icon ().



Quick Menu Overview



NOTE

- If the tab is green (i.e. , this indicates the current function is activated.

Viewing the Version Information

On the **Version** section, you can view the Bios version, EC version, and Quick Menu version.

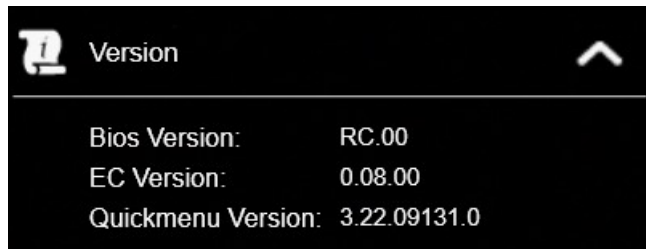

Viewing the Battery Charge Cycles

On the **Battery Charge Cycles** section, you can view the battery charge cycle and battery status.

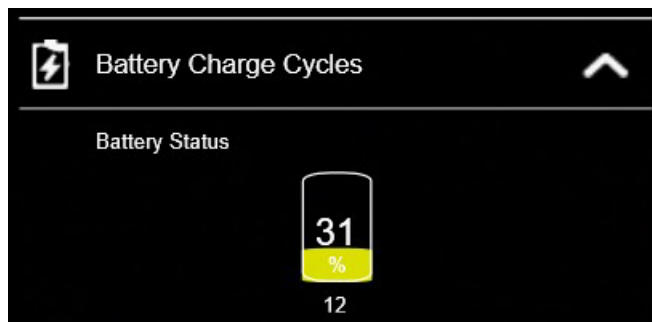

Battery Charging Protection Setting

On the **Battery Charging Protection Setting** section, select the protection setting.



NOTE

- Tap  to view a detailed description of each battery charging protection mode.

There are four available options:

- **Regular Mode:** In this mode the battery will be fully charged.
- **Optimized Battery Charging (OBC):** Battery charging will stop at 80% to reduce battery aging.
- **Temperature Control Mode (TCM):** To extend the lifetime of the battery, charging is enhanced based on DURABOOK intelligent algorithm and battery temperature.
- **DURA² Charging (D2C):** To maximize battery performance and lifespan, charging is enhanced based on DURABOOK intelligent algorithm and battery temperature. Battery charging will stop at 80%.

Configuring the Programmable Button (P)

On the **P Button Setting** section, you can assign the function for the **P** button.

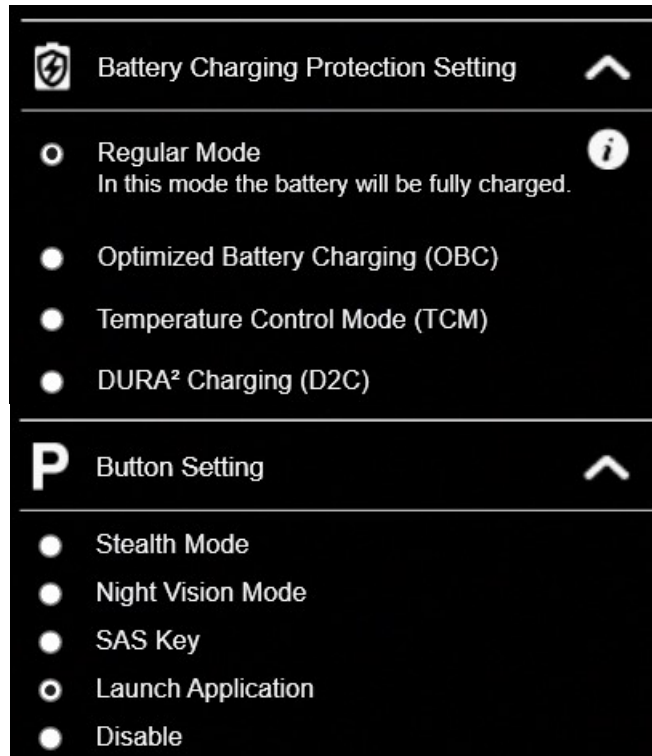

There are six available options:

- **Barcode trigger:** Scan the barcode (if the barcode scanner is integrated).
- **Stealth Mode:** Turn off the LCD backlight, LEDs, speakers, camera flash, and RF devices.
- **Night Vision:** Provides 1.7 nits of display brightness for mission critical situations. (For selected models).
- **SAS Key:** Shortcut key for launching the Windows Security screen.
- **Launch Application:** Shortcut key for launching a specific application. To assign the application, refer to the "Assigning an Application to the P Button" section.
- **Disable:** No function.

Configuring the Up/Down Button

On the **Up/Down Button Setting** section, you can assign the function for the **Up/Down** button.

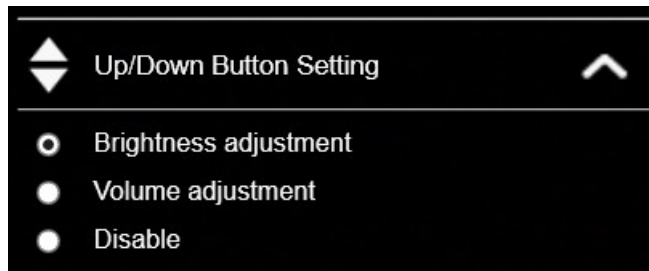

There are three available options:

- **Brightness adjustment:** To adjust screen brightness level.
- **Volume adjustment:** To adjust volume level.
- **Disable:** No function.



Configuring the Touchscreen Settings

Your tablet PC is equipped with a touchscreen. Using the touchscreen, you can navigate the screen by using touch gestures (any input from your finger, a glove, or a stylus).

CAUTION!

Do not use any sharp object, such as a pen or pencil, on the touchscreen to prevent scratches.



NOTE

- An optional protective film has been attached to the screen before shipment. You should change the film when it gets worn out.

You can select the desired touch screen mode in the Quick menu.

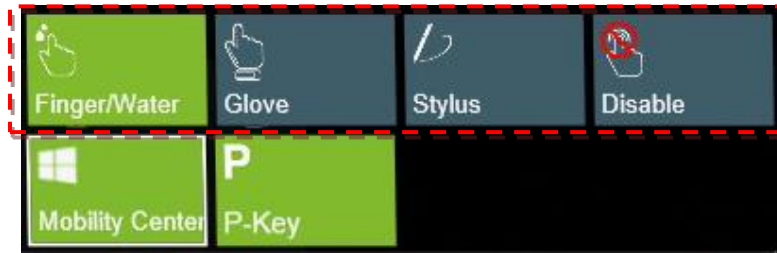

Select one of the available options:

- Select **Finger/Water** if you are using your fingertips.
- Select **Glove** if you are wearing gloves.
- Select **Stylus** if you are using a stylus.
- Select **Disable** if you don't want to use the touch function. When the confirmation message appears, select **Yes** to disable the touch function.

 **NOTE**

- If the touchscreen mode is set to **Glove** or **Stylus** and the touchscreen is wet (i.e. from a spilled liquid), the touch function will not respond to any input. Make sure to keep the screen dry to ensure proper operation.

If you select "**Disable**", the touch screen function could only be resumed by using mouse.

Assigning an Application to the P Button

Tap the **P-Key** tab to assign an application to the **P** button. Select the desired application and click **Open**.

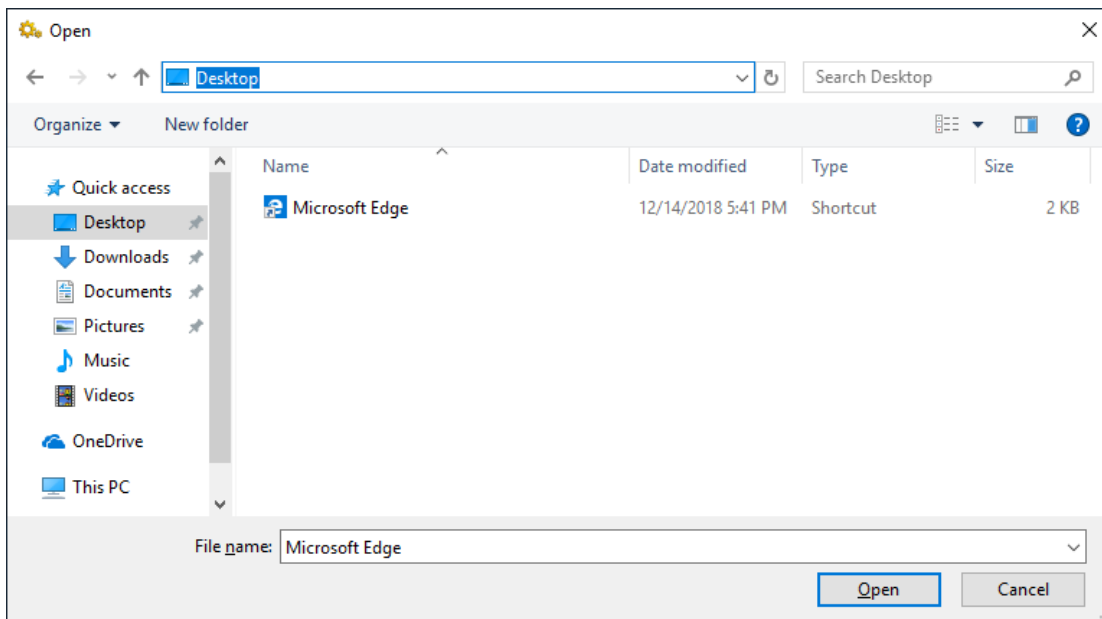

Accessing the Mobility Center

Tap the **Mobility Center** tab to adjust or configure the brightness, volume level, battery status, screen orientation, external display, sync, and presentation settings.

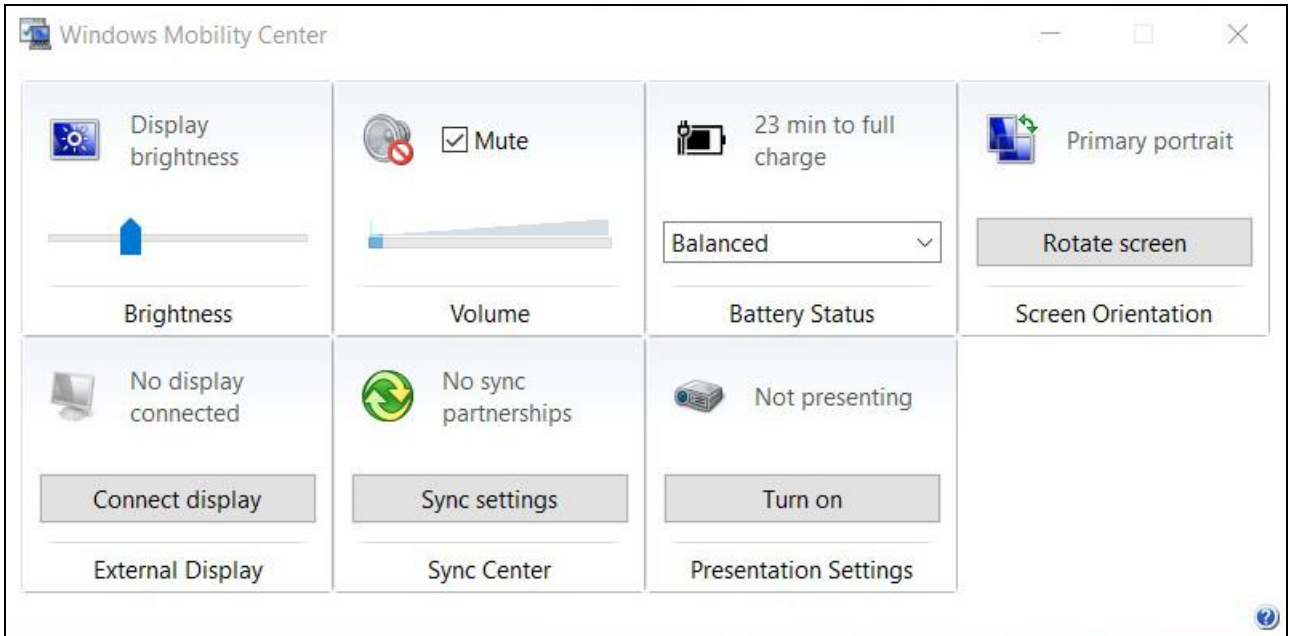

Using the Camera

Using the Camera application, you can use this tablet PC to take photos or videos.

Opening the Camera App

To access the Camera application, do one of the following:

- a. Tap  > **Camera**.

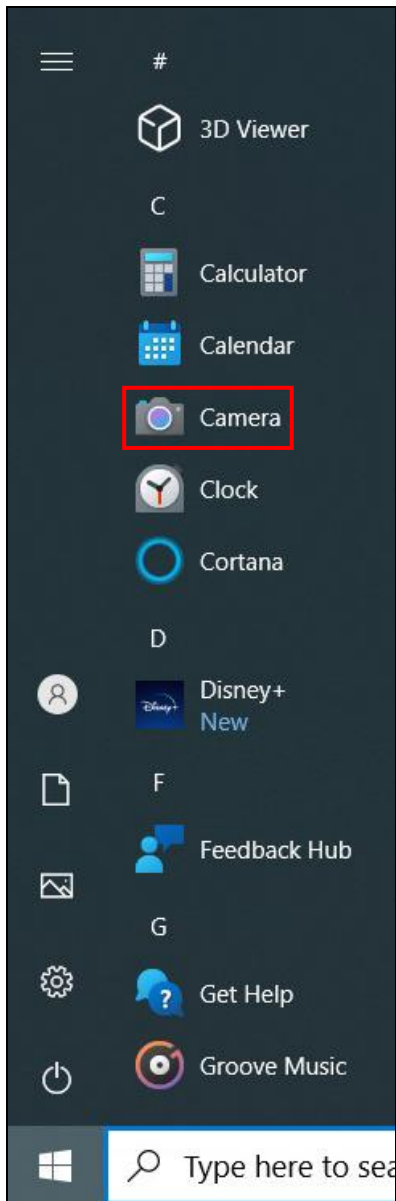

b. In Windows search box, enter 'camera'. Then tap **Camera**.

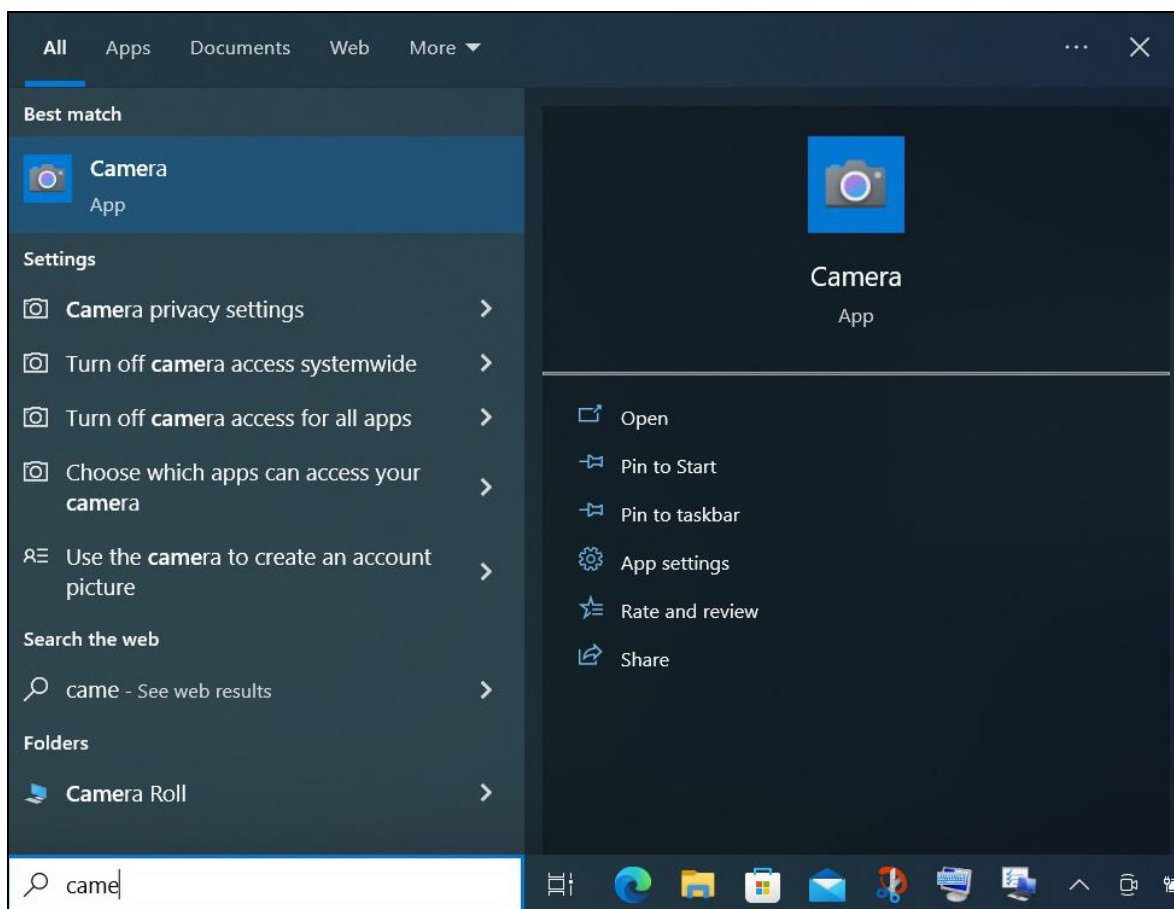

Taking Photos

Tap  to capture a photo.

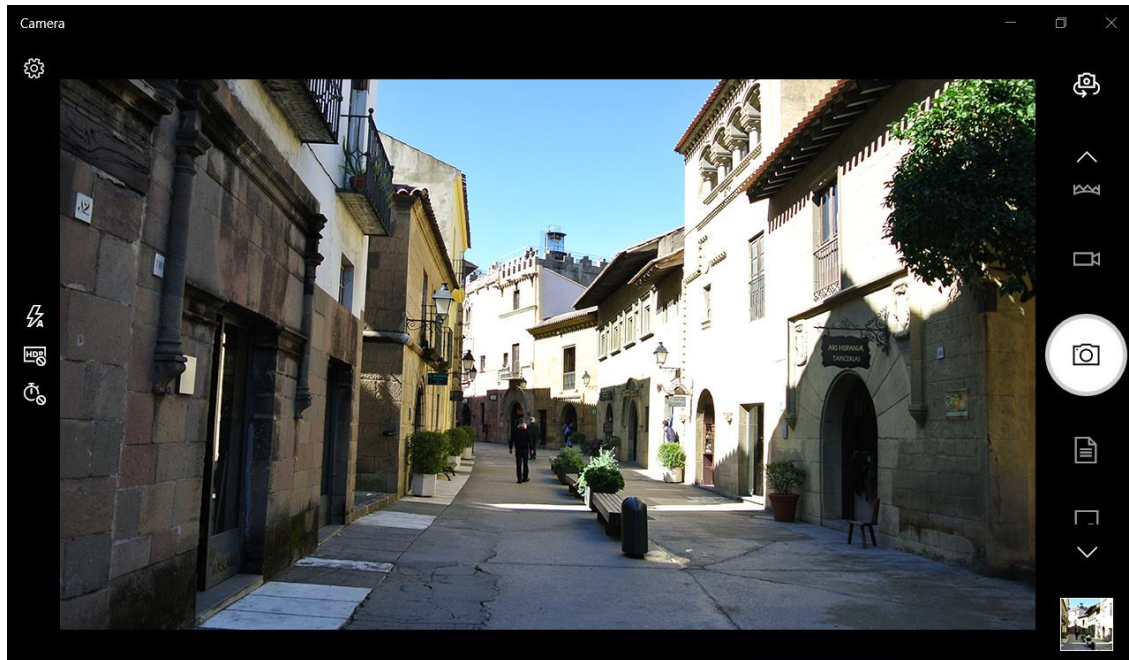





NOTE

- To switch between front and rear cameras, tap .

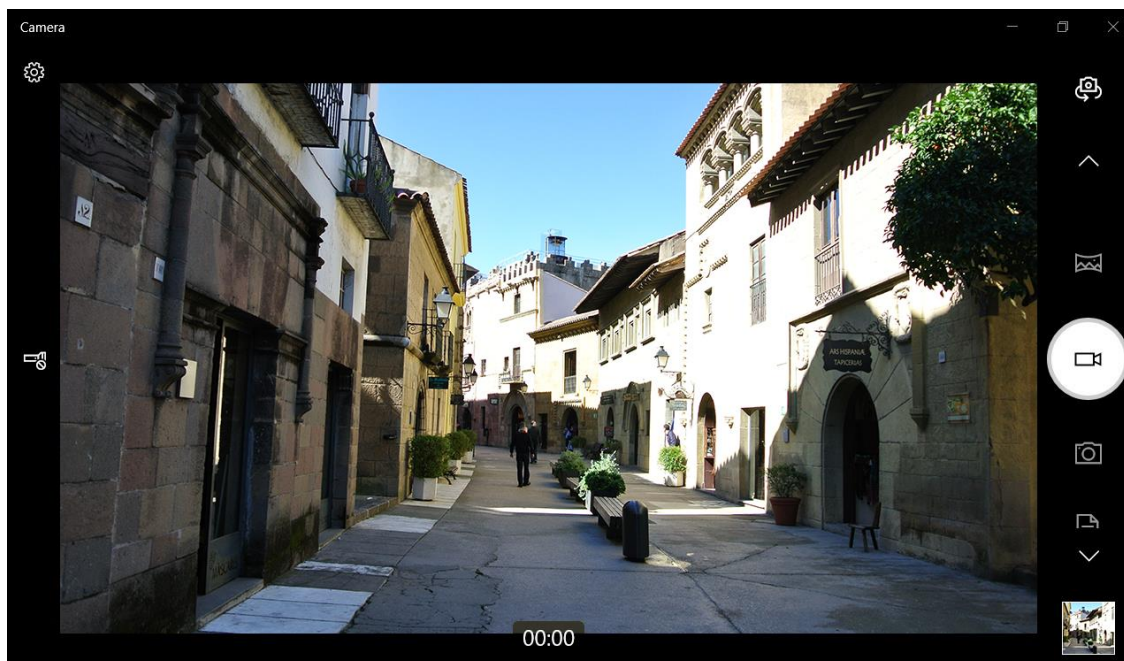
Recording Videos



1. Tap  to switch to Video mode.





2. Press  to start recording a video. The recording time appears on the bottom on the screen.
3. To pause/resume recording the video, tap  /  respectively and to stop recording the video, tap .

Setting a Flash Mode





In photo capturing mode, tap  to select the desired flash mode.

- : Flash is off
- : Flash is on
- : Automatic flash



In video recording mode, tap / to toggle the camera LED flash on or off.





Setting Photo Timer

Tap  to toggle the desired time delay.



- : Self-timer is off
- : 2-second self-timer
- : 5-second self-timer
- : 10-second self-timer

Switching Between Modes

Tap on your preferred shooting mode. If the mode is not visible, tap / or slide the mode bar up/down to see more shooting modes:



- : Take a panorama picture.
- : Record a video.
- : Take a photo.
- : Automatically adjusted mode for capturing a document.
- : Automatically adjusted mode for capturing a whiteboard.

Adjusting Focus

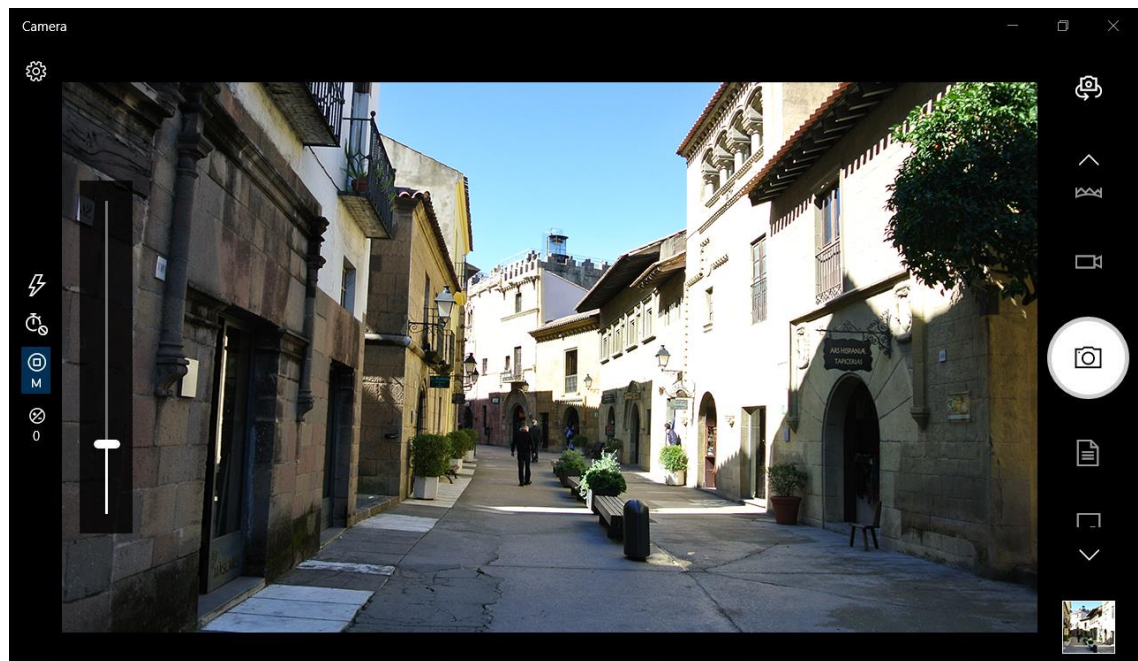
1. Tap  and slide on the Pro mode.
2. Tap  to display the focus control slider.
3. Do the following:
 - Tap and drag the slider upwards (or downwards if necessary) to focus automatically (**auto**), manually (**M**), or use infinity focus (∞).



Adjusting Brightness

1. Tap  and slide on the Pro mode.
2. Tap  to display the brightness control slider.
3. Do the following:
 - Tap and drag the slider upwards to brighten your photo or video.

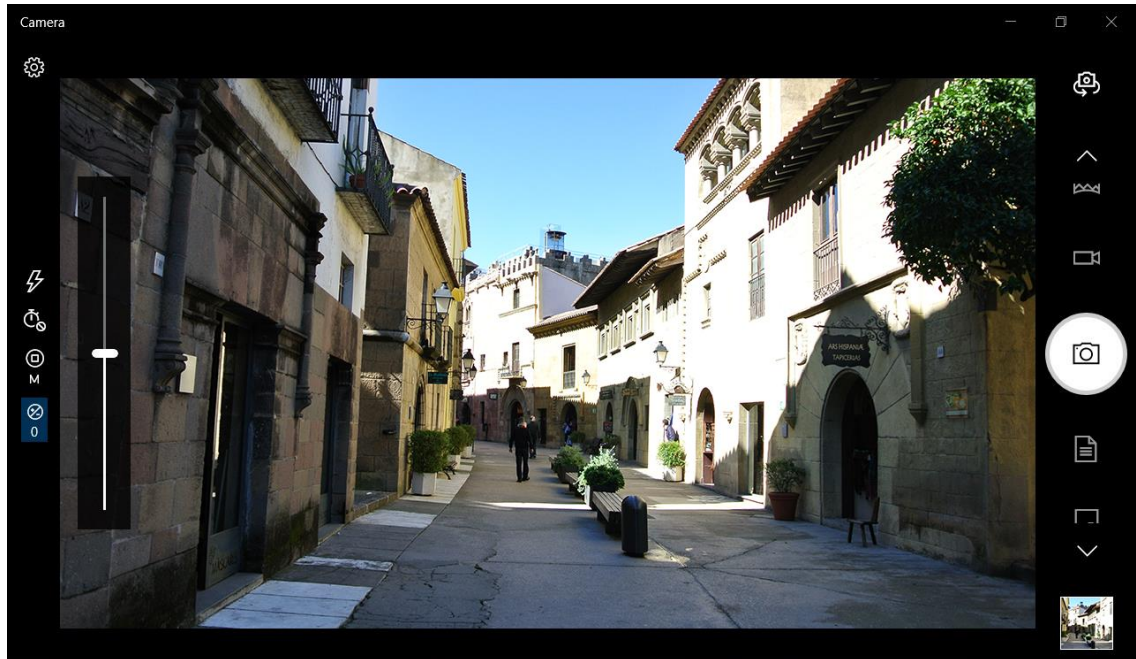

- Tap and drag the slider downwards to darken your photo or video.

Configuring Camera Settings

1. Tap  to enter the Settings menu.



2. Select the desired menu option and setting.

Menu Option	Description
<i>Camera settings</i>	
When I press and hold the camera button	Select the action when a camera button is pressed.
Pro mode	Enable or disable to show advanced controls for photos and videos.
Framing grid	Show or hide the framing grid lines.
<i>Photo settings</i>	
Photo quality	Select the aspect ratio of the photos.
Time lapse	If the setting is set to On, the system will keep taking photos until the camera button is pressed.
<i>Video settings</i>	
Video quality	Set the video resolution.
Flicker reduction	Select the flicker reduction setting: <ul style="list-style-type: none"> • 50 Hz/60 Hz: To reduce the flickering that may occur when recording video under fluorescent light. • Auto: To set flicker reduction automatically.
<i>Related settings</i>	
Select the related settings that can be configured in the Settings app or try out experimental features.	

Viewing Photos/Videos

After taking a photo or recording a video, tap the thumbnail (in the bottom-right corner) to view the most recent photo or video taken.

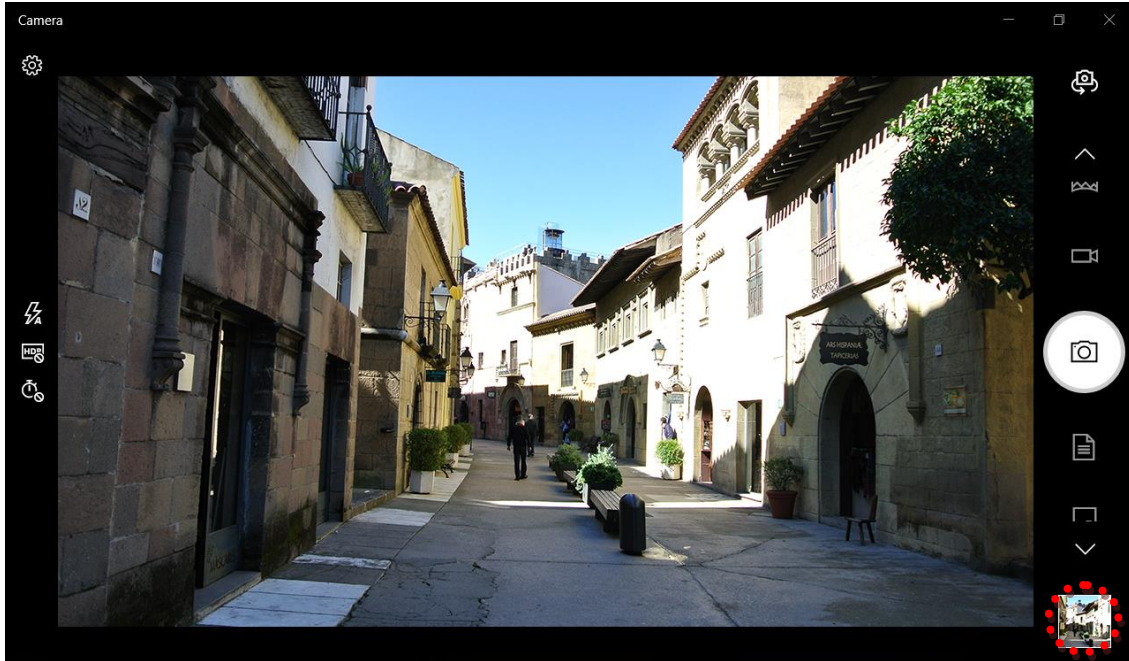

Swipe right to see other photos or videos in your collection.

Making Connections

This chapter will guide you on installing peripheral devices to maximize the use of your tablet PC.

Installing the MicroSD Memory Card

To insert a MicroSD memory card:

1. Remove the battery pack. Refer to *Removing the Battery* section.
2. Pull open the I/O port cover.
3. Push the memory card into the memory card slot until it clicks into place.

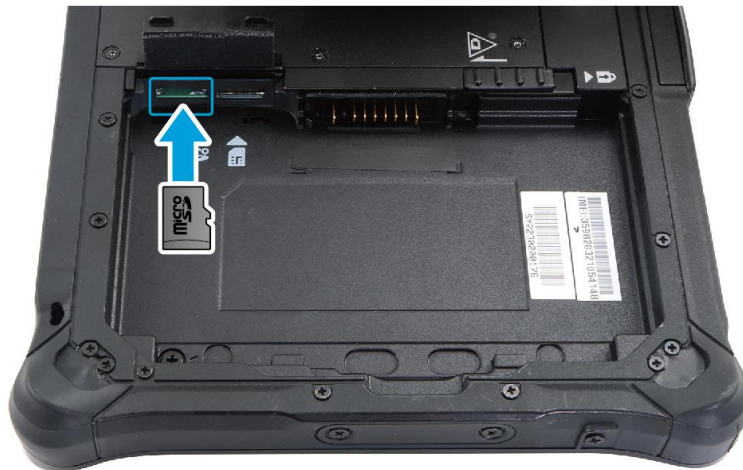

Installing the SIM Card

You can use a SIM card for wireless Internet access.



NOTE

- Check the availability of service and plan rates of data connection with your network service provider.

To insert a SIM card:

1. Remove the battery pack. Refer to *Removing the Battery* section.
2. Pull open the I/O port cover.
3. Push a valid SIM card into the SIM card slot until it clicks into place.

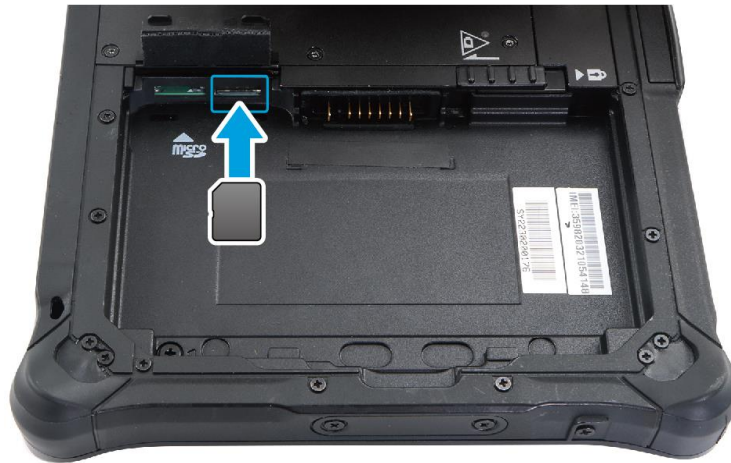

Connecting the Microphone/Headset

Your tablet PC is equipped with audio combo jack that enables you to use the headset or microphone.

- ❖ To connect to a headset, open the I/O port cover and plug the stereo headphone cable into the audio combo jack.



- ❖ To connect to a microphone, open the I/O port cover and plug the microphone cable into the audio combo jack.



NOTE

- The headset and microphone are not included in the package. They are sold separately.

Installing the Pen Holder

To install the pen holder, follow the steps below:

1. Remove the 2 screws from the left side of the tablet PC.

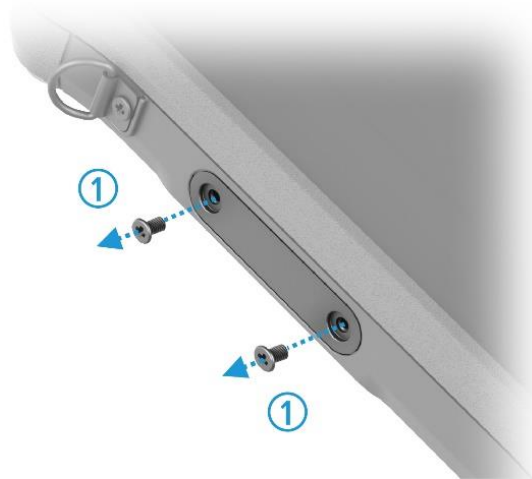

2. Align and secure the pen holder to the tablet PC with the supplied screws.

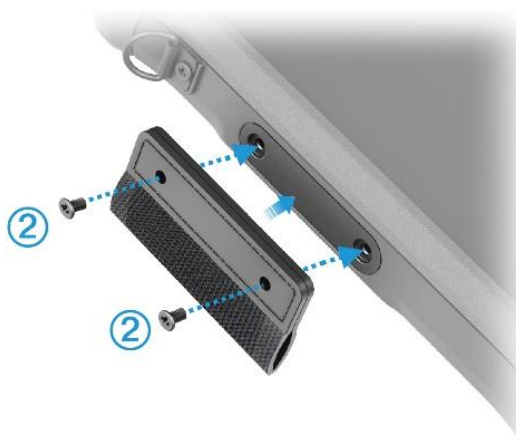

3. Insert the pen into the pen holder.



Connecting USB Devices

You can connect your tablet PC to other USB devices, such as a mouse, keyboard, digital camera, printer, or an external hard disk drive.

Those devices that support USB 3.2, connect to the following port:

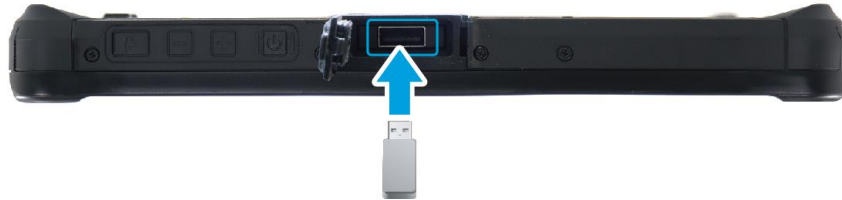

 **NOTE**

- The USB type-A port is optional and is available only for selected models.

1. Pull open the I/O port cover.
2. Connect one end of the USB cable to the USB port of your tablet PC.
3. Connect the other end of the cable to the USB device (if necessary).

Those devices that support USB-C, connect to the following port:

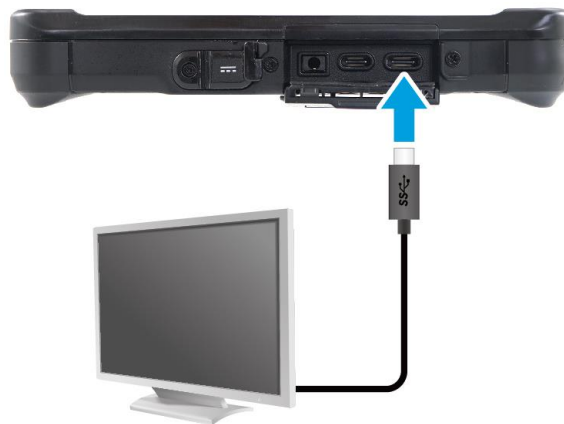

1. Push down and pull to open the I/O port cover.
2. Connect one end of the USB cable to the USB port of your tablet PC.
3. Connect the other end of the cable to the USB device (if necessary).

 **NOTE**

- The USB cable is not included in the package. It is sold separately, or it may come with your USB device.

Those devices that support Thunderbolt 4 and the PD adapter, connect to the following port:

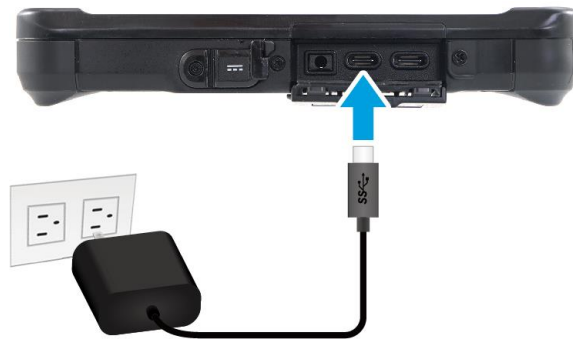

1. Push down and pull to open the I/O port cover.
2. Connect one end of the USB cable to the USB port of your tablet PC.
3. Connect the other end of the cable to the USB device (if necessary).



NOTE

- The USB cable is not included in the package. It is sold separately, or it may come with your USB device.

Connecting to Wireless Connections

Your tablet PC can connect and communicate with other wireless-enabled devices.



NOTE

- Do not disassemble the bumper. Otherwise, the antenna may be damaged, resulting in poor reception.

Connecting to a Bluetooth Device

Your tablet PC can connect and communicate with other Bluetooth-enabled devices. By default, the Bluetooth function is disabled.

To add a device, follow the steps below:

1. Tap the arrow icon (▲) on the system tray to display hidden icons.
2. Tap the Bluetooth icon (📶) and select **Add a Bluetooth Device**.

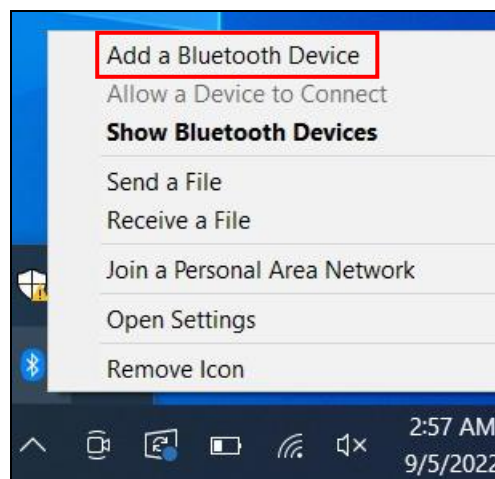

3. Tap + and select the kind of device you want to add.

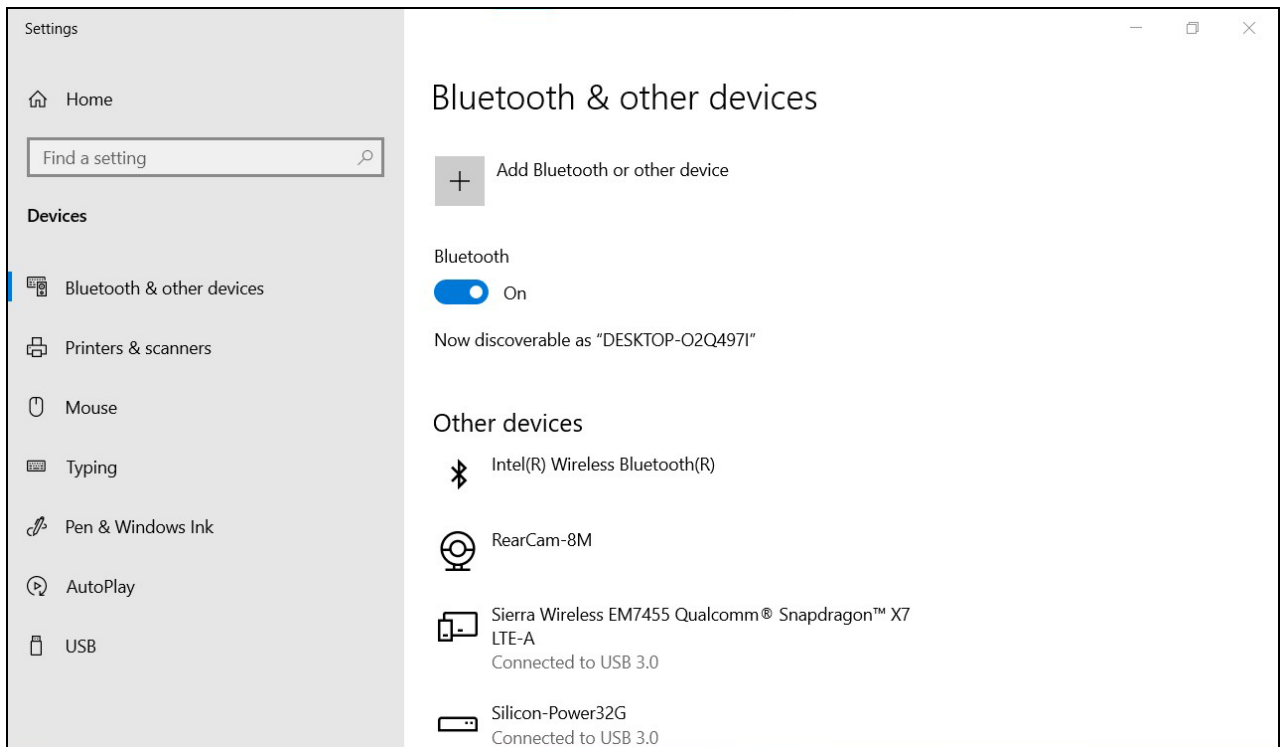

4. Select the device you want to connect. Verify the pairing code on the screen of your device and pairing device match, then tap **Connect** to start pairing.

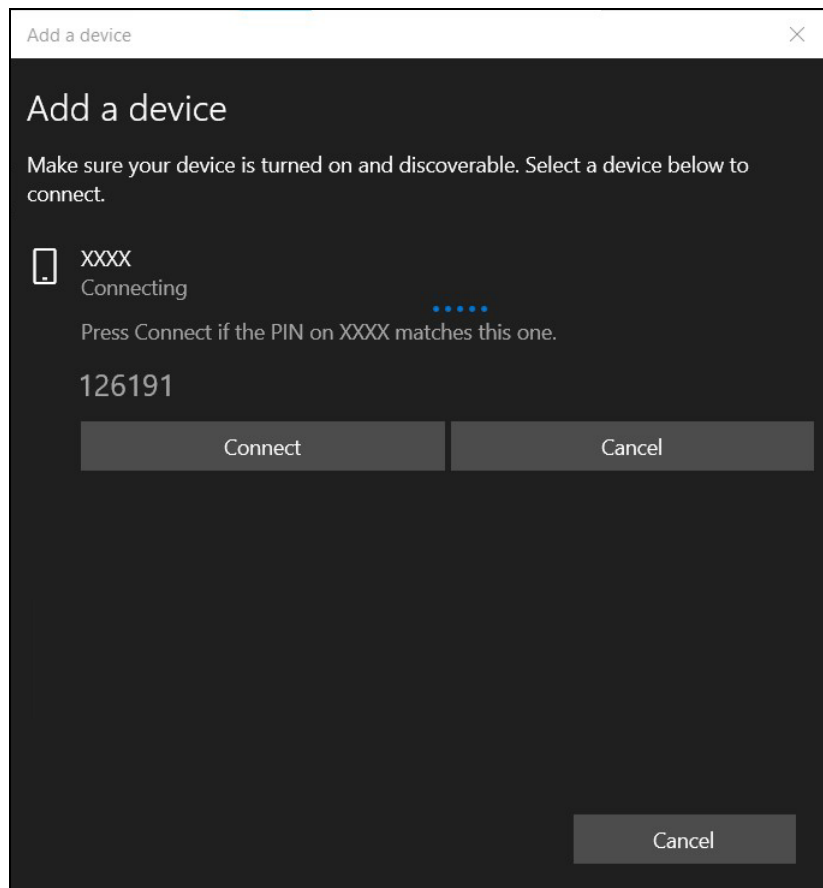

Making Connections



NOTE

- If the device that you want to add does not appear on the screen, please check if the device is turned on and is discoverable.
5. Tap **Done** to complete the pairing connection.

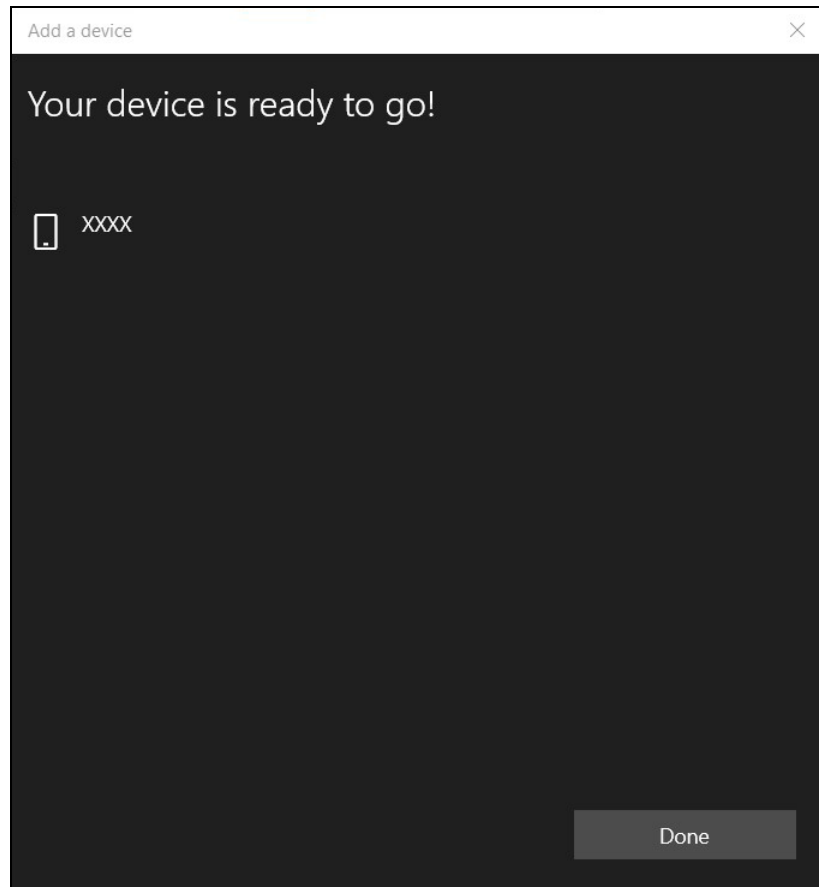

NOTE

- Most Bluetooth-enabled devices need to be paired with your tablet PC. The PIN you enter on the tablet PC must be the same PIN to be entered on the other Bluetooth device.
- Once a partnership has been created, connecting to that device again will no longer require entering the PIN.
- To disconnect from the Bluetooth-enabled device, select the device in the Bluetooth menu and tap **Remove device**.

Connecting to a Wireless Local Area Network

Your tablet PC comes with a WLAN module. A wireless network can be added either when the network is detected or by manually entering the settings information.

To connect, follow the steps below:

1. Tap the wireless network icon (📶) on the system tray.



2. Available wireless network connections are displayed. Tap the desired wireless network.
3. Tap **Connect**.
Some networks require a network security key or a password.

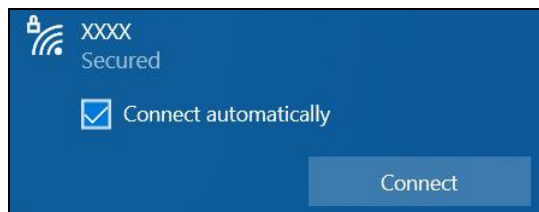



TIP

Check **Connect automatically** box to automatically connect to this network when it is available.

4. Enter the network security key.

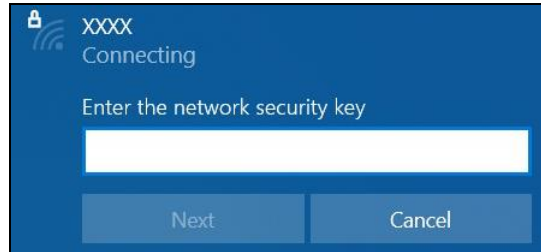

5. Tap **Next**. After the connection is established, you can see the wireless icon (📶) in the Notification area.



NOTE

- Wi-Fi access requires service from a wireless service provider. Contact your service provider for more information.
- Actual wireless connectivity will depend on system configuration. Please contact your dealer for more information.
- To disconnect from the wireless network, select the network in the wireless in the wireless network list and tap **Disconnect**.

Connecting to a Wireless Wide Area Network (WWAN)

With **WWAN** function, it allows your tablet PC to connect to the Internet using mobile or cellular data networks.

To connect, follow the steps below:

1. Insert a valid SIM card into the SIM card slot (refer to *Installing the SIM Card*).
2. Tap the wireless network icon (🌐) on the system tray. Then tap **Cellular** to enable the Internet connection via mobile data network.

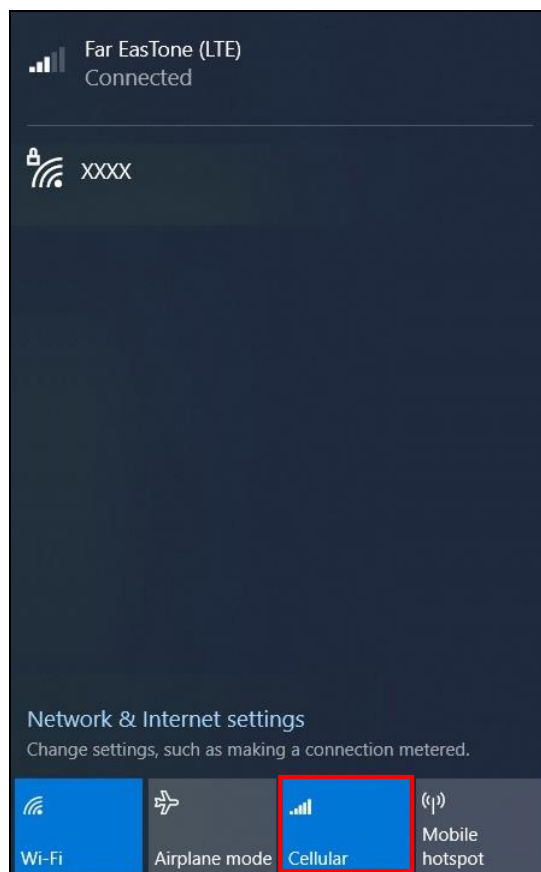

3. Select the mobile network carrier and tap **Connect** to establish the connection.

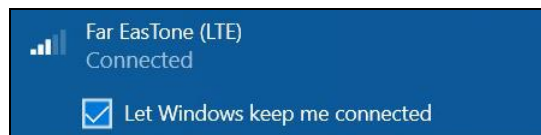

TIP

Check **Let Windows keep me connected** box to allow the system to automatically connect to this mobile data network.

Using the BIOS Setup Utility

Your tablet PC has a BIOS setup utility which allows you to configure important system settings, including settings for various optional functions of the tablet PC. This chapter explains how to use the BIOS setup utility.

BIOS Setup Menu

The BIOS Setup Utility allows you to configure your tablet PC basic settings. When you turn your tablet PC on, the system reads this information to initialize the hardware so that it can operate correctly. Use the BIOS Setup Utility to change your tablet start-up configuration. For example, you can change the security and power management routines of your system.

Starting the BIOS Setup Utility

You can enter the BIOS setup utility and press [Setup] button while the tablet PC is booting, that is between the time you turn on the tablet PC and before the Windows interface appears.



NOTE

- You can also connect your device with an external keyboard first before starting the BIOS Setup Utility. Shut down your tablet PC completely (power off) and restart it and then press the **Delete** button to enter the setup utility.



Main Menu

The Main Menu displays the system overview information about the device, including the system date and time.

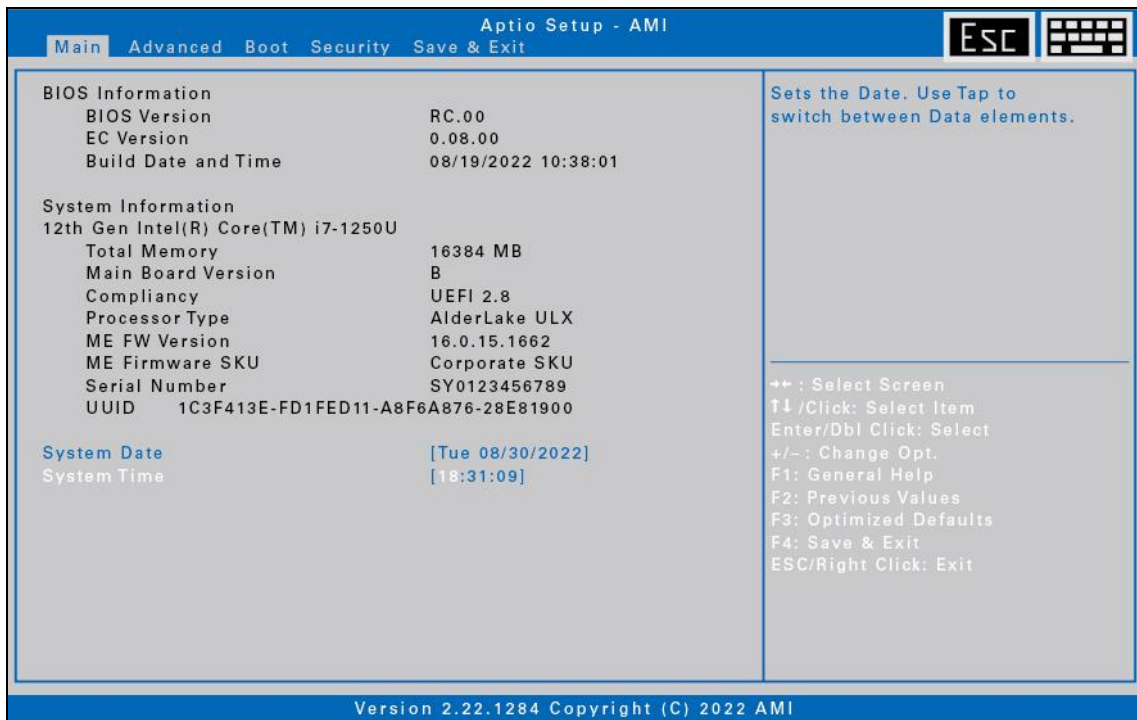

Item	Description
BIOS Information	Display the BIOS version detected during boot up.
System Information	Display the CPU name, total memory, mainboard version, compliancy, processor type, ME FW version and SKU, serial number, and BIOS UUID.
System Date	Set the system date.
System Time	Set the system time.

Advanced Menu

The Advanced Menu allows you to configure specific system settings.

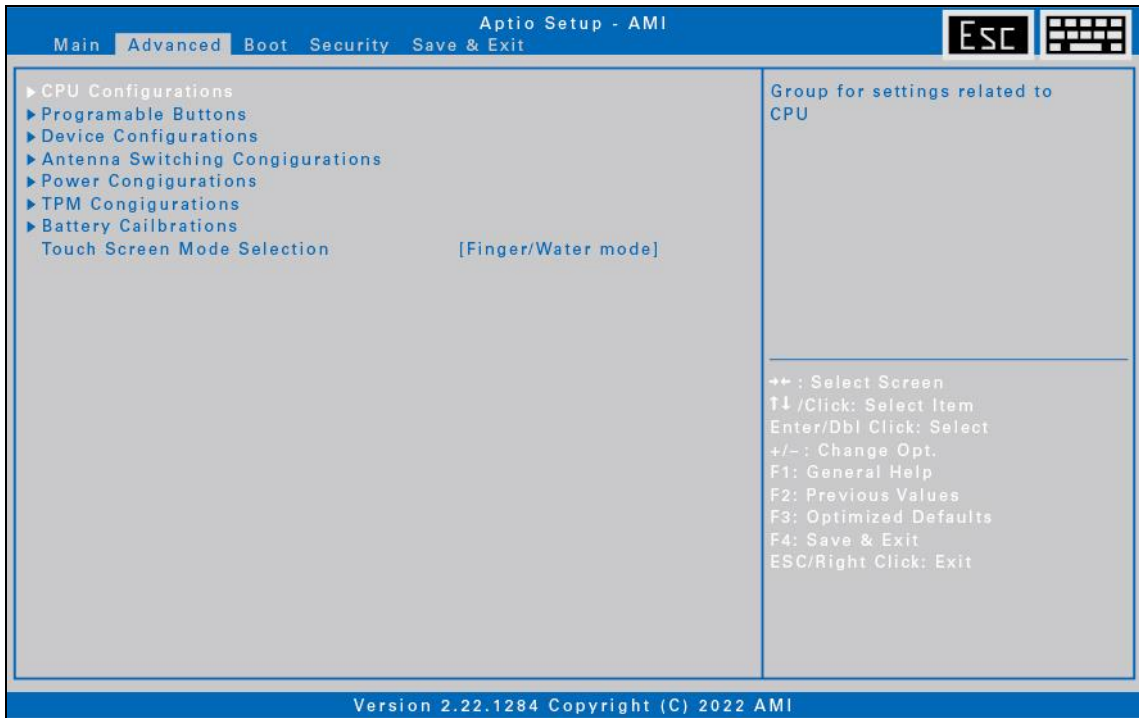

Item	Description
CPU Configuration	Configure the CPU parameters.
Programmable Buttons	Set the function of the P button and Volume Up/Down button.
Device Configuration	Enable or disable the left-expansion module, SD card reader, TPM device, HD audio, touch screen, front and rear camera, digitizer, Intel AMT, WLAN, Bluetooth, WWAN, and GPS.
Antenna Switching Configurations	<ol style="list-style-type: none"> (1) Enable/disable the device to automatically switch to the external GPS antenna when it is affixed on a docking station. (2) Enable/disable the device to automatically switch to the external WWAN antenna when it is affixed on a docking station. (3) Enable/disable the device to automatically switch to the external GPS when it is affixed on a docking station.
Power Configuration	Configure the power management settings including resume on AC power, bridge-battery support in standby mode, and battery-protection function.

Item	Description
TPM Configurations	Configure Trusted Computing settings.
Battery Calibrations	Calibrate the battery pack.
Touch Screen Mode Selection	Select the touch screen mode.

Boot Menu

The Boot Menu allows you to configure the boot settings and boot sequence.

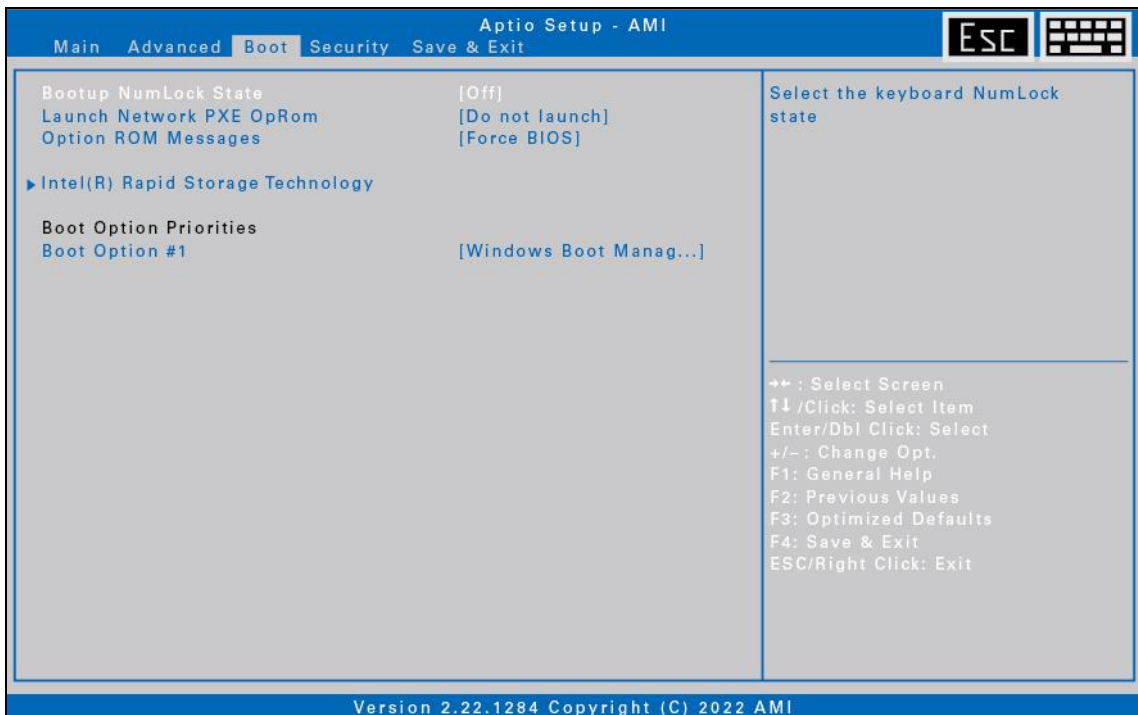

Item	Description
Boot NumLock State	Select the keyboard NumLock state.
Launch Network PXE OpRom	Control the execution of UEFI and Legacy PXE Option Rom.
Option ROM Messages	Set the display mode for Option ROM.
Intel® Rapid Storage Technology	Manage the RAID volumes on the Intel® RAID Controller.
Boot Option Priorities	Set the system boot order.

Security Menu

The Security Menu allows you to set or change the Administrator and User passwords.

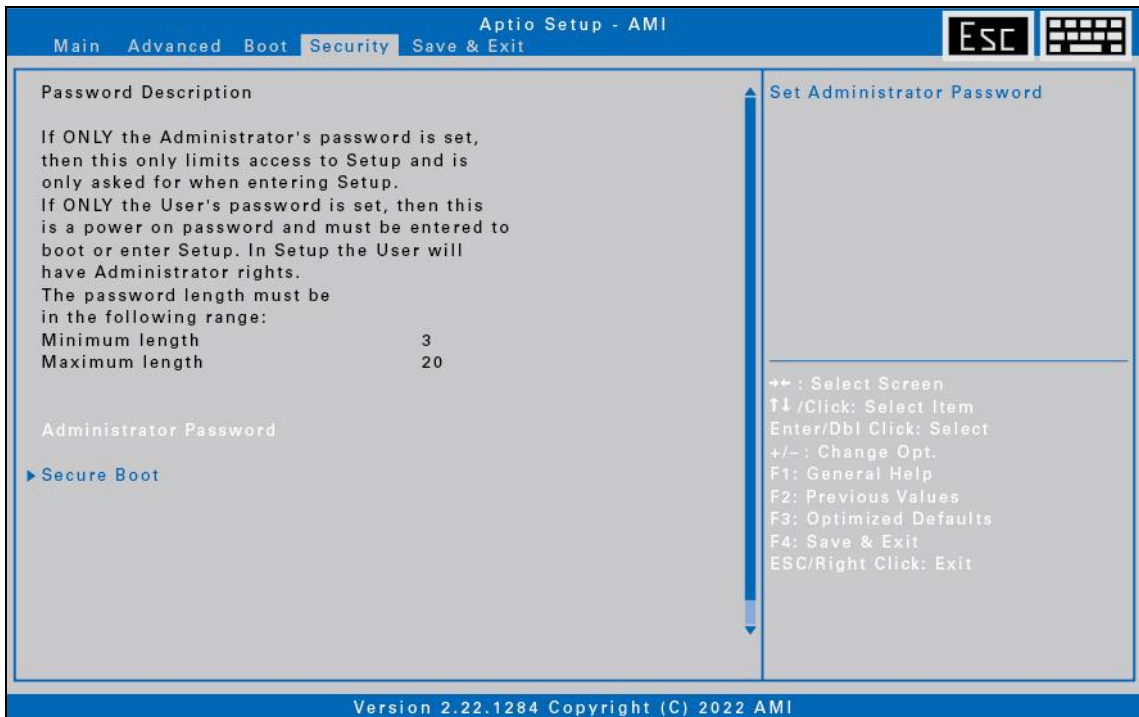

Item	Description
Administrator Password	Create or change the Administrator password.
Secure Boot	Customize the Secure Boot settings.

Save & Exit Menu

The Save & Exit Menu allows you to save/discard the changes and restore the default values for all setup options before leaving the BIOS Setup Menu.

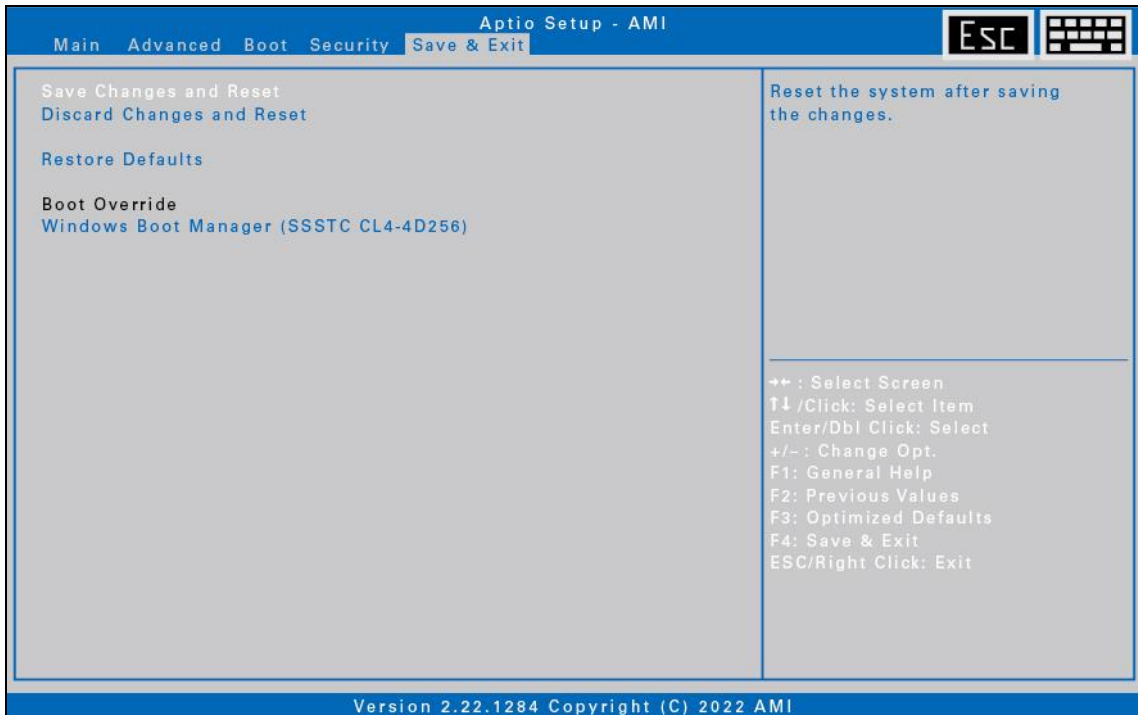

Item	Description
Save Changes and Reset	Reset the system after saving the changes.
Discard Changes and Reset	Reset the system setup without saving any changes.
Restore Defaults	Restore the default values for all the setup options.
Boot Override	Shortcut to the Windows Boot Manager.

Maintaining and Caring for Your Tablet PC

Taking care of your tablet PC will reduce the risk of damage to your device and ensure that it operates properly.

To help you maintain the quality and function of your tablet PC, this chapter provides guidelines on how to protect, store, clean, and travel with your device.

Protecting Your Tablet PC

To safeguard the integrity of the data stored on your tablet PC as well as the device, please follow the precautions described below:

- Install an anti-virus program to monitor potential viruses that could damage your files.

Storing and Handling Your Tablet PC

General Storage and Handling Guidelines

- Use your tablet PC at the recommended temperature—between 0°C (32°F) and 55 °C (131 °F)—to ensure optimal performance (Actual operating temperature depends on product specifications.)
- Avoid placing your tablet PC in a location subject to high humidity, extreme temperatures, mechanical vibrations, direct sunlight, or heavy dust. Using your device in extreme environments for long periods of time can result in product deterioration and a shortened product life.
- Do not place heavy objects on top of the tablet PC as this may damage the display.
- Do not operate in an environment with metallic dust.
- Store and use your tablet PC on a flat and steady surface. Do not stand the tablet PC on its side or store it in an upside-down position. The impact from dropping or an object hitting the device may cause damage.
- Do not cover or block any ventilation openings on the tablet PC. For example, do not place the tablet PC on a bed, sofa, rug, or other similar surface. Overheating may occur, which could result in damage to your tablet PC.
- Keep your tablet PC away from that are vulnerable to damage from heat, as

the device can become very hot during operation.

- Keep your tablet PC at least 13 cm (5 inches) away from electrical appliances that can generate a strong magnetic field such as a TV, refrigerator, motor, or a large audio speaker.
- Avoid moving your tablet PC abruptly from a cold to a warm place. A temperature difference of more than 10°C (18°F) may cause condensation inside the unit, which may damage storage media.

Display and Touchscreen Guidelines

- Use your finger or the stylus on the touchscreen surface. Using a sharp or metallic object, such as a pen or pencil, may scratch and damage the display, thereby causing errors.
- Use a soft cloth to remove dirt on the display. The touchscreen surface has a special protective coating that prevents dirt from sticking to it. Not using a soft cloth may cause damage to the special protective coating on the touchscreen surface.
- Turn off the tablet PC power when cleaning the display. Cleaning the display with the power on may cause improper operation.
- Do not use excessive force on the display. Avoid placing objects on top of the display as this may cause the glass to break, thereby damaging the device.
- Expect a slower response time when using the touchscreen at lower temperatures (less than 5°C or 41°F). A normal response time may be restored upon returning to room temperature.
- Refer to Windows online support for instructions on recalibrating the touchscreen display when there is noticeable problem with the touchscreen function (e.g., improper display resolution or unresponsive touchscreen).
- LCD image sticking occurs when a fixed pattern is displayed on the screen for a prolonged period of time. You can avoid the problem by limiting the amount of static content on the display. It is recommended that you either use a screen saver or turn off the display when it is not in use.
- To maximize the life of the backlight display, allow the backlight to automatically turn off as a result of power management.

Battery Pack Guidelines

- Do not expose the battery to temperatures below 0°C (32°F) or above 45°C (113°F). This may adversely affect the battery pack.
- While the battery may not provide 100% capacity at temperature extremes, its capacity is restored when the battery temperature return to a normal range, around 20°C (68°F).
- Your battery will last longer during the day if it is used, charged and stored between 50°F and 86°F (10°C and 30°C).
- Charge the battery nightly where the temperature will remain around 68°F (20°C). Your battery may not last as long through the day if you charge it at higher or lower temperatures.
- Allow unrestricted airflow while the device is connected to external power. Make sure that the fan inlet and outlet are unobstructed.
- Avoid exposure to extreme temperatures for long periods as this can shorten battery charge life or damage the battery.
- If your battery is charged in a cold (less than 5°C/41°F) or very warm (greater than 45°C/113°F) environment, it is possible that the Battery LED will indicate that the charge has stopped; However, this does not necessarily mean that your battery is fully charged.
- Read and follow all battery precautions in the Safety section.
- Use only batteries of the same kind as replacements.
- Turn the power off before removing or replacing batteries.
- To avoid malfunction of the tablet PC and losing any unsaved data, do not install or remove the battery pack while the device is in sleep mode.
- Avoid touching the contacts of the battery while installing or removing the battery. Hold the battery by the sides instead to prevent the malfunction of the system.
- Do not tamper with the batteries.
- Keep batteries away from children.
- Before storing your battery, read and follow the recommendations in the Battery Tips section.
- Dispose of used batteries according to local regulations.
- Recycle if at all possible.

Battery Charging Recommendations

The battery is a consumable item that will eventually wear out and need replacement.



NOTE

- If the battery pack has deteriorated, ensure it is replaced with a new one.

The lifespan of the battery depends upon its usage. To prolong battery life, follow the recommendations below:

- Keep the number of charges and discharges to a minimum. It is best to charge the device no more than once a day and only when the charge drops to 10% or lower. If you need to charge the battery continuously, consider using the battery charging protection mode, for example, OBC or D2C. For more information, refer to "Battery Charging Protection Setting". The charging time will vary depending on the charging protection mode.
- Monitor the temperature inside the battery to prevent it from becoming too high. Charge your device indoors in an open area where the temperature is between 50°F and 86°F (10°C and 30°C).

To further enhance battery charging and prolong battery life, we advise charging the battery nightly, where the temperature will remain around 68°F (20°C).

- Charging the battery while the system is fully running will take longer. We recommend charging the battery when the system is in hibernation or sleep mode to increase the charging speed.

Modern Standby Mode

To achieve longer battery life, your device supports modern standby mode. This is an advanced sleep mode that enables networking and communication devices to automatically switch between active and low-power modes based on the software activity of the system while the monitor is off. For example, you can still receive emails in this mode even though the device is in sleep mode. To resume active mode, press the **Power** button on your device.



NOTE

- To avoid the loss of any unsaved data while the device is in modern standby mode, do not remove the battery and AC adapter simultaneously from the device. In addition, ensure there is enough battery charge if running on the battery power.

Cleaning Your Tablet PC

Cleaning the Outside Case

- Disconnect external power and turn off the device.
- Remove the battery.
- Add a small amount of water to a soft cloth and clean the device case. Do not use paper products because they can scratch the surface.
- Wipe off any excess liquid with a soft cloth.
- Reinstall the battery.

CAUTION: Aerosols, solvents, or strong detergents are not recommended cleaning solutions and may void your warranty. For system decontamination recommendations please contact your support representative.

Cleaning the Display

Use a soft, dry cloth. In some cases, you can use a small amount of water to remove streaks or smears. For difficult display cleaning tasks, use a 70/30 mixture of isopropyl alcohol and water. Do not use paper products because they can scratch the screen.

Cleaning the External Power Connector

The external power connector may sometimes be exposed to moisture and/or contamination causing an unreliable connection to the external power source. Clean the connector with a cotton swab dipped in electronics grade isopropyl alcohol.

Cleaning the RJ-45 / USB Connectors

If the connector pins get dirty, clean the connector with a cotton swab dipped in electronics grade isopropyl alcohol.

Traveling With Your Tablet PC

Before traveling with your tablet PC, make sure you prepare and follow the precautions described below:

- Back up the data on your hard drive to a flash drive or other storage device. As an added precaution, bring an extra copy of your important data.
- Make sure that the battery pack is fully charged.
- Ensure that your tablet PC is turned off.
- Confirm that all the connector covers are closed completely to ensure the device's waterproof integrity.
- Disconnect the AC adapter from your tablet PC and take it with you. Use the AC adapter to power the device and charge the battery.
- Hand-carry your tablets PC onto an airplane, train, or bus. Do not check it in as luggage.
- If you need to leave your tablet PC in a car, store it in the trunk to avoid exposing it to excessive heat.
- When going through airport security, do not carry your tablet PC through the magnetic detector (the device you walk through) or expose it to a magnetic wand (the handheld device used by security personnel). It is recommended that you send the tablet PC and any flash drives through the X-ray machine (the device where you set your bags).
- If you plan to travel abroad with your tablet PC, consult your dealer for the appropriate AC power cord for use in your country of destination.

Troubleshooting

This chapter advises you on what actions to take when solving common computer problems that may be caused by issues with hardware or software.

Preliminary Checklist

Here are the initial steps you should follow before taking further actions when encountering any problem:

1. Try to identify and isolate which part of the tablet PC is causing the problem.
2. Make sure that you turn on all peripheral devices before turning on the tablet PC.
3. If you are having trouble with an external device, make sure that the cable connections are correct and secure.
4. Make sure that the configuration information is properly set in the BIOS Setup program.
5. Ensure that all the device drivers are correctly installed.
6. Make note of your observations. Are there any messages on the screen? Do any indicators light up? Do you hear any beeps? Detailed descriptions are useful to the service personnel when you need to consult someone for assistance.
7. If any problem persists after you follow the instructions in this chapter, contact an authorized dealer for help.

Solving Common Problems

Battery Problems

The battery does not charge

- To prevent possible damage to the battery, the device does not allow the battery to charge if the internal temperature of the battery gets too low (< 5°C or < 41°F) or too high (> 50°C or > 122°F). If possible, charge the battery in a location with a moderate temperature of around 20°C (68°F).
- If possible, turn off the device while the battery is charging.
- If the battery is new or has been stored for a week or more, follow this procedure:
 1. Make sure the device is turned off.
 2. Remove the battery.
 3. Connect the AC adapter to the device and an AC wall outlet, and then turn on the device by pressing the POWER button.
 4. Let the device complete the boot process. Then reinstall the battery.

- Allow the system to remain idle for one hour with the AC adapter connected to the device.
- The Battery Power LED lights when the battery starts charging.
- If the battery still fails to start charging after an hour, remove the battery, wait several seconds, and then install it again.
- If the battery does not begin charging within several minutes, return the unit for service.

The batteries take much longer than seven hours to charge.

- Under moderate temperatures, about 20°C (68°F), the device’s battery takes approximately 4 to 5 hours to completely charge.
- As the battery temperature approaches the ends of its temperature range (5 °C/ 41°F to 50°C/122°F), it may take longer to charge the battery.

The batteries don’t last very long.

- Calibrate the battery. If your battery is new or has not been used for several weeks, calibrating the battery accurately sets the gas gauge.
- As your battery ages, its maximum capacity naturally decreases and even the best maintained batteries eventually need to be retired. Consider replacing the battery if you are not getting the usage you need from it.
- To meet ENERGY STAR® requirements, Wake on LAN is enabled by default. If running on battery power this may decrease battery run-time. To change Wake on LAN settings, open the Device Manager, Network Adapters and select the LAN device. Open the device Properties and select Power Management. Disable the Wake on LAN setting by unchecking. Allow this device to wake the computer.

The gas gauge isn’t full after charging the battery.

- This may indicate that the charging process terminated prematurely.

The gas gauge reads “full,” but the charging LED is still lit.

- If you charge your battery daily, rely on the gas gauge reading to determine battery capacity. The charging process may continue even if the gas gauge reads full. External power can be removed because the battery is virtually full.

My battery seems to have less and less capacity.

- If your battery is new, or if you are using it for the first time, you will need to calibrate it (see Battery Calibration) prior to using it.
- As your battery ages, the maximum capacity that it can hold naturally decreases and even the best maintained batteries eventually need to be retired. Consider replacing the battery if you are not getting the usage you need from it.

BT Wireless Transmission Problems

I cannot connect to another device with BT wireless technology.

- Ensure that you have activated BT feature on both devices.
- Make sure that the distance between the two devices is within the acceptable limit and that there are no walls or other obstructions between the devices.
- Confirm that the other device is not in “Hidden” mode.
- Verify that both devices are compatible.

Display Problems

The display performance is slow.

- The temperature may be too cold. Move the device to a warmer operating environment.

The underlined, inverse, and hypertext characters are difficult to read on the screen.

- Right click on the Windows Desktop, select Personalize, Colors to change the color and style of your Windows.

I changed my display resolution, but I see no difference on the screen.

- Select > Start, Power, Restart.

Nothing happens when I try to use the stylus on my touch screen.

- If you cannot select objects accurately with the stylus, you may need to calibrate the touch screen.

The touch screen doesn't respond after a suspend.

- The touch screen needs a few seconds to work after a suspend. Wait a moment and try again.

Hard Disk Problems

The hard disk will not spin up so the device can't boot up.

- This occurs if the unit is exposed to extreme low temperatures. This is not a hardware failure associated with the hard disk. The integrated hard disk drive heater will warm the drive to a safe operating temperature.

The device does not startup properly.

- Make sure you remove any USB drives from the unit before you start it.
- Connect the AC adapter to charge the battery if it is not charged.

- If the battery does not begin charging, perform the following:
 - Remove the battery.
 - Connect the AC adapter.
- Turn on the device by pressing the POWER button.
- Reinstall the battery. The Battery LED is a steady orange while the battery is charging.

Hard disk recovery process on Win10

1. Select **Start**  > **Setting**

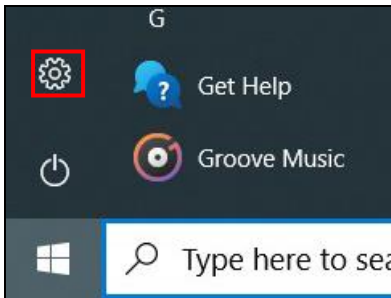

2. Select **Recovery** under **Update & Security**.
3. Under **Reset this PC**, Click **Get started**.

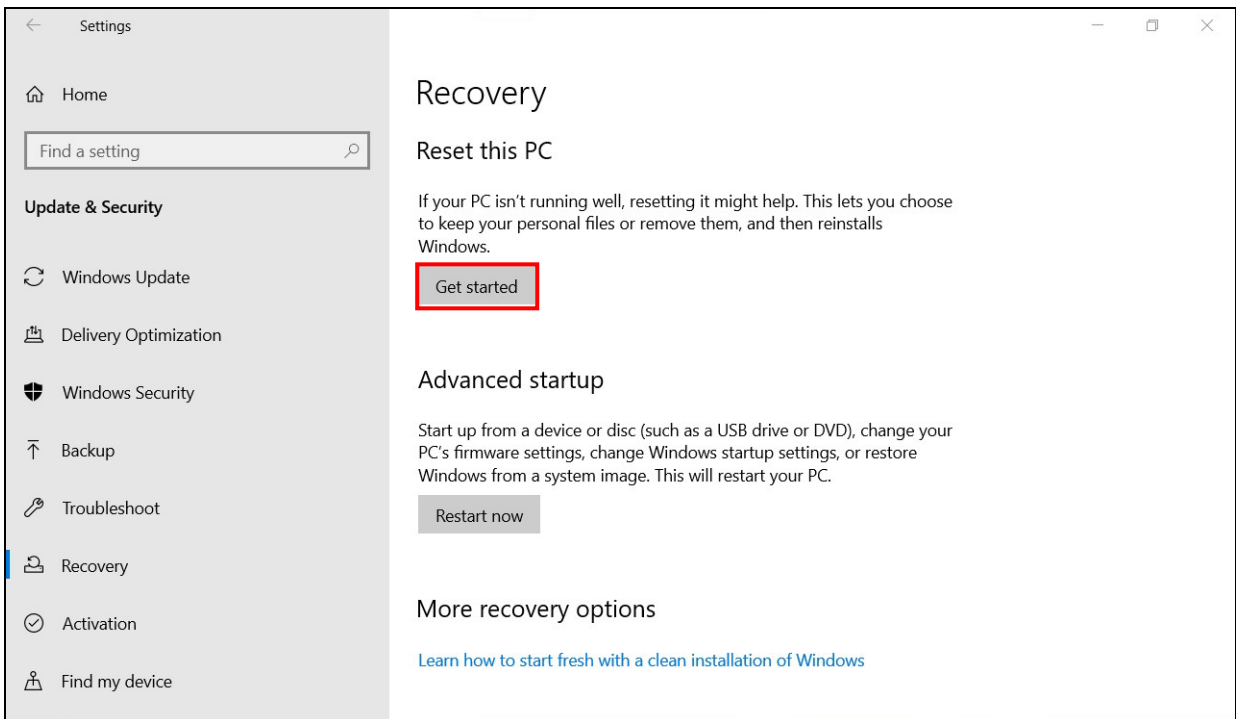

Troubleshooting

4. Select one of the two options depending on your needs.
 - **Keep my files** (requires around 3 to 4hr)
 - **Remove everything** (requires around 5 to 6hr)

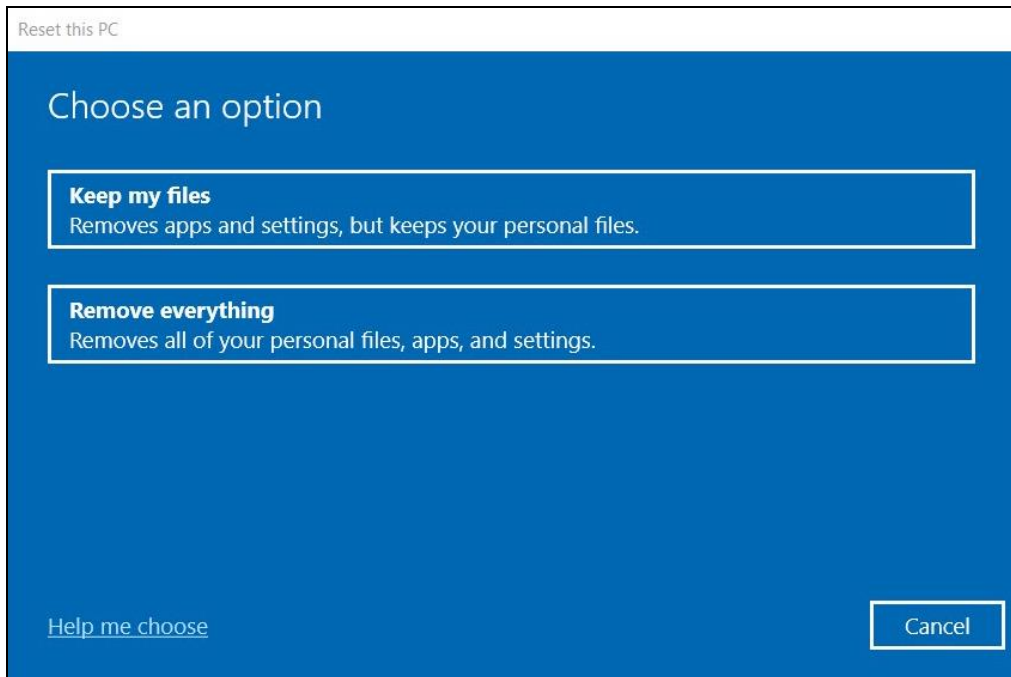

Proceed with the recovery process.



NOTE

- If you see a message as shown below that means the recovery media is not available. Insert your Windows installation or recovery media, and restart your PC with the media.
- You can also try to change your device's firmware settings, change Windows startup settings, and more by selecting **Settings > Update & Security > Recovery > Advanced startup > Restart now.**

Other Problems

The device won't turn on.

- Make sure a fully charged battery is properly installed.
- Connect external power to charge the battery if it is not charged.
- If you are using the AC adapter, check the electrical outlet you are using to make sure it is working properly.
- If the device does not turn on, reset the device by holding down the POWER button for at least ten seconds, release it, and then press the POWER button again.

The device won't turn off.

1. Select >Start, Power, Restart.
2. If that does not work, press Ctrl + Alt + Del and then select Task Manager.
3. If any programs are open, use your arrow keys to highlight each one and select End task. Repeat this until all programs are closed.
4. If that still does not work, press and hold the POWER button for approximately ten seconds and then release it.

The device doesn't make any sounds, even during boot-up.

- You may have enabled Stealth Mode. Disable Stealth Mode.

Appendix

Copyright

Copyright© 2024. All rights reserved.

No part of this user manual may be transmitted, stored in a retrieval system, or translated into any language or computer language, in any form or by any means, without the prior written permission of the manufacturer. Information is subject to change without prior notice.

Specifications

Model Name	R8
Durability	<ul style="list-style-type: none"> – MIL-STD 810H certified (Drop, Shock, Vibration, Rain, Dust, Altitude, Freeze/Thaw, High/Low Temperature, Temperature Shock, Humidity, Explosive Atmosphere, Salt Fog) – MIL-STD 461G certified (Conduction, Radiation, Conducted Susceptibility, Radiated Susceptibility) – Optional ANSI/UL 121201, Class I, Division 2 – 6' drop 26 faces – IP 66 certified – Aluminum-magnesium alloy chassis – Port covers – Sunlight readable display – Optional swappable battery technology
Operating System	Windows® 11 Pro 64-bit
Processors	<ul style="list-style-type: none"> – Intel® Core™ i7-1250U (12th Gen) Processor with vPro™ (12M Cache, up to 4.7 GHz, 2P+8E cores) – Intel® Core™ i5-1230U (12th Gen) Processor with vPro™ (12M Cache, up to 4.4 GHz, 2P+8E cores) – Intel® Pentium® Gold Processor 8500 (8M Cache, up to 4.4 GHz, 1P+4E cores)
Graphics	Intel® Iris® Xe Graphics
Memory	Onboard 8GB up to 16GB (LPDDR4x)
Storage	128GB NVMe PCIe SSD <ul style="list-style-type: none"> – Optional 256GB/512GB/1TB PCIe SSD
Display	8.0" LCD (1280 × 800) <ul style="list-style-type: none"> – 800 nits DynaVue® sunlight readable display with capacitive multi-touch screen – Optional with digitizer

Model Name	R8
	<ul style="list-style-type: none"> – User selectable touch mode for Finger/Water, Glove or Stylus programmable function
Audio	<ul style="list-style-type: none"> – Integrated microphone – Intel® High Definition Audio Compliant – Integrated speaker × 1
Camera	<ul style="list-style-type: none"> – Integrated 2.0 MP front-facing camera – Optional 8.0 MP auto-focus rear camera with flash
Keyboard & Input	4 buttons (1 user-definable key)
Communications	<ul style="list-style-type: none"> – Intel® Wi-Fi 6E AX211 (802.11 ax) – Bluetooth® V5.3 – Optional GPS and 4G LTE multi-carrier mobile broadband – Optional RF antenna pass-through for GPS, WWAN and WLAN¹
Security	<ul style="list-style-type: none"> – Intel® vPro™ Technology (per CPU options) – TPM 2.0 – NIST BIOS compliant – Stealth mode – Night vision mode – Optional smart card reader^{1,2} – Optional LF/HF-RFID (NFC) reader^{1,2} – Optional UHF-RFID (NFC) reader^{1,2}
I/O Ports	<ul style="list-style-type: none"> – Thunderbolt 4 × 1 – USB 3.2 Gen 2 (type C) × 1 (support DP) – Audio in/out (combo jack) × 1 – microSD card (microSDXC) × 1 – Docking connector (20-pin Pogo) × 1 – Nano SIM card × 1 – DC-In jack × 1 – Optional USB 3.2 Gen1 (type A) × 1² – Optional 10/100/1000 Ethernet (RJ45) × 1² – Optional serial port (RS232) × 1² – Optional 1D/2D barcode reader × 1² – Optional RF antenna pass-through for GPS, WWAN and WLAN¹
Expansion Slot	<ul style="list-style-type: none"> – Optional magnetic stripe reader^{1,2} – Optional smart card reader with LF/HF-RFID (NFC) or UHF-RFID (NFC) or RS232/RJ45/USB 3.2 Gen1 (type A) ^{1,2}
Power	AC adapter: 100-240V, 50Hz-60Hz, 65W Main battery Li-Ion, 7.6V, 3600mAh, 8.5 hours ³

Appendix

Model Name	R8
	<ul style="list-style-type: none">– Optional long life battery Li-Ion 7.6V, 7200mAh, 17 hours³– Optional swappable battery: 5 minutes swap time⁴³
Environment	<ul style="list-style-type: none">– Temperature Operating: - 20°C ~ 60°C / - 4°F ~ 140°F Storage: - 46°C ~ 71°C / - 51°F ~ 160°F– Humidity: 5% ~ 95%
Dimension	227 mm (L) x 150 mm (W) x 20.5 mm (H)
Weight	0.86 kg
Warranty	3-year limited warranty standard



NOTE

- Specifications are subject to change without any prior notice.
- ¹ Contact your sales representative for feature availability.
- ² Mutually exclusive options.
- ³ Tested using the MobileMark 2014 battery life benchmark. Results may vary under different situations including hardware configuration, software, operating conditions, power management settings and ⁴. The system will stay operating (within 300 seconds in standby mode) when user swaps the battery.

Regulatory Statement

Federal Communications Commission

Statement

This equipment has been tested and found to comply with the limits for a Class B digital device, pursuant to part 15 of the FCC Rules. These limits are designed to provide reasonable protection against harmful interference in a residential installation. This equipment generates, uses and can radiate radio frequency energy and, if not installed and used in accordance with the instructions, may cause harmful interference to radio communications. However, there is no guarantee that interference will not occur in a particular installation. If this equipment does cause harmful interference to radio or television reception, which can be determined by turning the equipment off and on, the user is encouraged to try to correct the interference by one or more of the following measures:

- Reorient or relocate the receiving antenna.
- Increase the separation between the equipment and receiver.
- Connect the equipment into an outlet on a circuit different from that to which the receiver is connected.
- Consult the dealer or an experienced radio/TV technician for help.

DECLARATION OF CONFORMITY

according to FCC 47 Part 15 Subpart B : Section 15.107 & 15.109

ICES-003 Issue 7 : 2020 Class B

ANSI C63.4-2014



Responsible Party : DURABOOK AMERICAS INC.

Address : 48329 Fremont Blvd., Fremont, CA 94538, USA

Phone Number : (510) 492-0828

Hereby declares that the product

Brand/Trademark : DURABOOK

Product : Fully Rugged Tablet PC

Model : R8XXXXXX (Where "X" may 0 to 9, A to Z, a to z or blank)

This device complies with Part 15 of the FCC Rules. Operation is subject to the following two conditions: (1) this device may not cause harmful interference, and (2) this device must accept any interference received, including interference that may cause undesired operation.

Declaration of Conformity

This device complies with part 15 of the FCC rules. Operation is subject to the following conditions:

- This device may not cause harmful interference.
- This device must accept any interference received, including interference that may cause undesired operation.

FCC Section 15.21 information for user:

Any changes or modifications not expressly approved by the party responsible for compliance could void the authority to operate equipment.

FCC RF Radiation Exposure Statement:

Portable Device

- This device and its antenna must not be co-located or operating in conjunction with any other antenna or transmitter.
- This device complies with FCC radiation exposure limits set forth for an uncontrolled environment.
- This equipment complies with FCC RF radiation exposure limits set forth for an uncontrolled environment for body-worn configuration in direct contact to the phantom.

RF Exposure Information (SAR)

- This device meets the government's requirements for exposure to radio waves. This device is designed and manufactured not to exceed the emission limits for exposure to radio frequency (RF) energy set by the Federal Communications Commission of the U.S. Government.
- The exposure standard for wireless devices employing a unit of measurement is known as the Specific Absorption Rate, or SAR. The SAR limit set by the FCC is 1.6W/kg.
- The FCC has granted an Equipment Authorization for this device with all reported SAR levels evaluated as in compliance with the FCC RF exposure guidelines.
- SAR information on this device is on file with the FCC and can be found under the Display Grant section of www.fcc.gov/oet/ea/fccid after searching on FCC ID: FKGR801 (WLAN), FKGW01R8 (WWAN)

Operation of transmitters in the 5.925-7.125 GHz band is prohibited for control of or communications with unmanned aircraft systems.

European Union CE Regulations

Europe: Models AX211NGW	
Software Version	22.120.1.9
Maximum Power Output	
(2400 - 2483.5 MHz) IEEE802.11 b/g/n/ax mode	15dBm \pm 1 dB max
(2400 - 2483.5 MHz) BLE / Bluetooth	9.5dBm \pm 1.5 dB max
(5150 - 5725 MHz) IEEE802.11 a/n/ac/ax mode	14.5dBm \pm 1 dB max
(5745 - 5875 MHz) IEEE802.11 a/n/ac/ax mode	14.5dBm \pm 1 dB max
(5945 - 7105 MHz) IEEE802.11 ax mode	13dBm \pm 1 dB max

Europe: Model EM7421

Software (Driver Package) Version:

Generic: 1.14.03.00_00_GENERIC_002.036_010

Band	Frequencies	Conducted Tx (Transmit) power tolerances
LTE frequency band support		
Band 1	2100 MHz	Tx: 1,920–1,980 MHz
		Rx: 2,110–2,170 MHz
Band 3	1800 MHz	Tx: 1,710–1,785 MHz
		Rx: 1,805–1,880 MHz
Band 7	2600 MHz	Tx: 2,500–2,570 MHz
		Rx: 2,620–2,690 MHz
Band 8	900 MHz	Tx: 880–915 MHz
		Rx: 925–960 MHz
Band 20	800 MHz	Tx: 832–862 MHz
		Rx: 791–821 MHz
Band 28	700 MHz	Tx: 703–748 MHz
		Rx: 758–803 MHz
Band 38	2600 MHz	Tx: 2,570–2,620 MHz
		Rx: 2,570–2,620 MHz
Band 40	2300 MHz	Tx: 2,300–2,400 MHz
		Rx: 2,300–2,400 MHz
Band 41	2500 MHz	Tx: 2,496–2,690 MHz
		Rx: 2,496–2,690 MHz
Band 42	3500 MHz	Tx: 3,400–3,600 MHz
		Rx: 3,400–3,600 MHz
Band 43	3700 MHz	Tx: 3,600–3,800 MHz
		Rx: 3,600–3,800 MHz

Appendix

WCDMA frequency band support			
Band 1	WCDMA 2100	Tx: 1,920–1,980 MHz	+23 dBm ± 1 dB
		Rx: 2,110–2,170 MHz	
Band 5	WCDMA 850	Tx: 824–849 MHz	+22 dBm ± 1 dB
		Rx: 869–894 MHz	
Band 8	WCDMA 900	Tx: 880–915 MHz	+23 dBm ± 1 dB
		Rx: 925–960 MHz	

In the 5150 - 5250MHz band: Indoor, including installations inside road vehicles, trains and aircraft, and limited outdoor use. If used outdoors, equipment shall not be attached to a fixed installation or to the external body of road vehicles, a fixed infrastructure or a fixed outdoor antenna.

In the 5250 - 5350MHz band: Indoor use, inside buildings only. Installations in road vehicles, trains and aircraft are not permitted. Outdoor use is not permitted.

In the 5470 - 5725MHz band: Indoor and outdoor use. Installations in road vehicles, trains and aircraft and use for UAS are not permitted.

In the 5945 - 6425 MHz band is restricted to indoor use only.

This restriction exists in Belgium (BE), Bulgaria (BG), Czech Republic (CZ), Denmark (DK), Germany (DE), Estonia (EE), Ireland (IE), Greece (EL), Spain (ES), France (FR), Croatia (HR), Italy (IT), Cyprus (CY), Latvia (LV), Lithuania (LT), Luxembourg (LU), Hungary (HU), Malta (MT), Netherlands (NL), Austria (AT), Poland (PL), Portugal (PT), Romania (RO), Slovenia (SI), Slovakia (SK), Finland (FI), Sweden (SE), Northern Ireland (UK(NI)), Switzerland (CH), Iceland (IS), Liechtenstein (LI) and Norway (NO).

In accordance with the relevant statutory requirements in the UK, the 5150 to 5350 MHz and 5945 to 6425 MHz frequency range is restricted to indoor use only in the United Kingdom.

The device complies with RF specifications when the device used at 1.5cm from your body.

	AT	BE	BG	CH	CY
	CZ	DE	DK	EE	EL
ES	FI	FR	HR	HU	IE
IS	IT	LT	LI	LU	LV
MT	NL	NO	PL	PT	RO
SE	SK	TR	SI	UK(NI)	



European Union CE Marking and Compliance Notices

This product follows the provisions of the European Directive 2014/30/EU.

This product follows the provisions of the European Directive 2014/35/EU.

This product follows the provisions of the European Directive 2014/53/EU.

This product follows the provisions of the European Directive 2009/125/EC.

This product follows the provisions of the European Directive 2012/19/EU.

This product follows the provisions of the European Directive 2015/863/EU.

RF exposure warning

- Any changes or modifications not expressly approved by the party responsible for compliance could void the authority to operate equipment.
- This device and its antenna must not be co-located or operating in conjunction with any other antenna or transmitter.
- End-users and installers must be provided with antenna installation instructions and transmitter operating conditions for satisfying RF exposure compliance.
- For product available in the USA/Canada market, only channel 1~11 can be operated. Selection of other channels is not possible.

IC Regulations

RSS-Gen Issue 4 8.4

This device complies with Industry Canada's licence-exempt RSSs. Operation is subject to the following two conditions: (1) This device may not cause interference; and (2) This device must accept any interference, including interference that may cause undesired operation of the device.

Le présent appareil est conforme aux CNR d'Industrie Canada applicables aux appareils radio exempts de licence. L'exploitation est autorisée aux deux conditions suivantes: (1) l'appareil ne doit pas produire de brouillage, et (2) l'utilisateur de l'appareil doit accepter tout brouillage radioélectrique subi, même si le brouillage est susceptible d'en compromettre le fonctionnement.

This Class B digital apparatus complies with Canadian ICES-003.

Cet appareil numérique de la classe B est conforme à la norme NMB-003 du Canada.

IC Exposure Statement:

This equipment complies with ISED radiation exposure limits set forth for an uncontrolled environment. End user must follow the specific operating instructions for satisfying RF exposure compliance. The portable device is designed to meet the requirements for exposure to radio waves established by the ISED. These requirements set a SAR limit of 1.6 W/kg averaged over one gram of tissue. The highest SAR value reported under this standard during product certification for use when properly worn on the body.

IC ID: 2697A-R801 (WLAN), 2697A-W01R8 (WWAN)

Canada, Industry Canada (IC) Notices

This Class B digital apparatus complies with Canadian ICES-003 and RSS-210. Operation is subject to the following two conditions: (1) this device may not cause interference, and (2) this device must accept any interference, including interference that may cause undesired operation of the device.

This device and its antenna(s) must not be co-located or operating in conjunction with any other antenna or transmitter.

- (i) the device for operation in the band 5150–5250 MHz is only for indoor use to reduce the potential for harmful interference to co-channel mobile satellite systems; (For devices installed in vehicles point i. is not required.)
- (ii) for devices with detachable antenna(s), the maximum antenna gain permitted for devices in the bands 5250-5350 MHz and 5470-5725 MHz shall be such that the equipment still complies with the e.i.r.p. limit;
- (iii) for devices with detachable antenna(s), the maximum antenna gain permitted for devices in the band 5725-5850 MHz shall be such that the equipment still complies with the e.i.r.p. limits specified for point-to-point and non-point-to-point operation as appropriate; and
- (iv) where applicable, antenna type(s), antenna models(s), and worst-case tilt angle(s) necessary to remain compliant with the e.i.r.p. elevation mask requirement set forth in section 6.2.2.3 shall be clearly indicated.

Devices shall not be used for control of or communications with unmanned aircraft systems.

Canada, avis d'Industry Canada (IC)

Cet appareil numérique de classe B est conforme aux normes canadiennes ICES-003 et RSS-210.

Son fonctionnement est soumis aux deux conditions suivantes : (1) cet appareil ne doit pas causer d'interférence et (2) cet appareil doit accepter toute

interférence, notamment les interférences qui peuvent affecter son fonctionnement.

Cet appareil et son antenne (s) ne doivent pas être situés ou fonctionner en conjonction avec une autre antenne ou émetteur.

- (i) l'appareil pour fonctionner dans la bande 5150-5250 MHz est réservé à une utilisation en intérieur afin de réduire les risques d'interférences nuisibles à la co-canal systèmes mobiles par satellite;
- (ii) pour les appareils avec antenne (s) détachable, le gain d'antenne maximal autorisé pour les appareils dans les bandes 5250-5350 MHz et 5470-5725 MHz doit être telle que l'équipement satisfait encore la pire limite;
- (iii) pour les appareils avec antenne (s) détachable, le gain d'antenne maximal autorisé pour les appareils dans la bande 5725-5850 MHz doit être telle que l'équipement satisfait encore la pire limites spécifiées pour le point-à-point et non point-à-point, le cas échéant; opération et
- (iv) l'angle d'inclinaison du pire (s) nécessaire pour rester conforme à la pire exigence de masque d'élévation énoncées dans la section 6.2.2 (3) doit être clairement indiqué.

EU RoHS

This product complies with the EU RoHS Directive 2011/65/EU as amended by (EU) 2015/863.

The above criteria do not apply to the RoHS exemptions. Exemption item: 7a, 7(c)-1 and 6c.

REACH - Substances of Very High Concern (SVHC)

According to article 33 in EU REACH, article manufacturer has the obligation to disclose information of substances included in candidate list of SVHC contained in products. If used in product and encourage suppliers to reduce and phase out such substance in product if commercially available.

SVHC list is based on the publication by European Chemicals Agency (ECHA).

<http://echa.europa.eu/candidate-list-table/>

VCCI

この装置は、クラスB機器です。この装置は、住宅環境で使用することを目的としていますが、この装置がラジオやテレビジョン受信機に近接して使用されると、受信障害を引き起こすことがあります。

取扱説明書に従って正しい取り扱いをして下さい。

VCCI – B

Cybersecurity Information

1. Security Update Period

The Tablet PC has a software and hardware support period of 5 years. Detailed information can be obtained from

<https://www.durabook.com/en/support/security-advisory/>

2. Report on Security Issue

To report any vulnerability found with the Tablet PC, user can submit the report through our vulnerability reporting page at

<https://www.durabook.com/en/support/security-advisory/>

Battery Statement

⚠ WARNING	
<ul style="list-style-type: none">• INGESTION HAZARD : This product contains a button cell or coin battery.• DEATH or serious injury can occur if ingested.• A swallowed button cell or coin battery can cause Internal Chemical Burns in as little as 2 hours.• KEEP new and used batteries OUT OF REACH of CHILDREN.• Seek immediate medical attention if a battery is suspected to be swallowed or inserted inside any part of the body.• non-replaceable batteries (type: CR2032, DC 3V)	

1. Remove and immediately recycle or dispose of used batteries according to local regulations and keep away from children. Do NOT dispose of batteries in household trash or incinerate.

2. Even used batteries may cause severe injury or death.

3. Call a local poison control center for treatment information.

4. The compatible battery type CR2032.

5. The nominal battery voltage DC 3V.
6. Non-rechargeable batteries are not to be recharged.
7. Do not force discharge, recharge, disassemble, heat above 60°C or incinerate. Doing so may result in injury due to venting, leakage or explosion resulting in chemical burns.
8. This product contains a non-replaceable button cell or coin battery.
9. Consult an authorized service center or authorized retailers for product service or assistance on proper disassembly or assembly of the product.

Battery Disposal

THIS PRODUCT CONTAINS A LITHIUM-ION OR NICKEL-METAL HYDRIDE BATTERY. IT MUST BE DISPOSED OF PROPERLY. CONTACT LOCAL ENVIRONMENTAL AGENCIES FOR INFORMATION ON RECYCLING AND DISPOSAL PLANS IN YOUR AREA.

WARNING EXPLOSION HAZARD

Class I, Division 2, Groups A, B, C, D, T Code T5

Class I, Zone 2, Groups IIC, T5

WARNING - EXPLOSION HAZARD - SUBSTITUTION OF COMPONENTS MAY IMPAIR SUITABILITY FOR CLASS I, DIVISION 2. And,

AVERTISSEMENT - RISQUE D'EXPLOSION - LA SUBSTITUTION DE COMPOSANTS PEUT ENDRE CE MATÉRIEL INACCEPTABLE POUR LES EMPLACEMENTS DE CLASSE I, DIVISION 2.

WARNING: TO PREVENT IGNITION OF A HAZARDOUS ATMOSPHERE, BATTERIES MUST ONLY BE CHARGED IN AN AREA KNOWN TO BE NON-HAZARDOUS. And,

AVERTISSEMENT- RISQUE D'EXPLOSION- AFIN D'ÉVITER TOUT RISQUE D'EXPLOSION, S'ASSURER QUE L'EMPLACEMENT EST DESIGNÉ NON DANGEREUX AVANT DE CHANGER LA BATTERIE.

WARNING - EXPLOSION HAZARD - DO NOT CONNECT OR DISCONNECT WHILE CIRCUIT IS LIVE UNLESS AREA IS KNOWN TO BE NON-HAZARDOUS. And,

AVERTISSEMENT - RISQUE D'EXPLOSION. NE PAS BRANCHER OU DÉBRANCHER TANT QUE LE CIRCUIT EST SOUS TENSION, À MOINS QU'IL NE S'AGISSE D'UN EMPLACEMENT NON DANGEREUX.

Battery: Japone Technology Inc., P/N : R8-M, R8-H

CLASS 2 LASER PRODUCT

IEC 60825-1:2014

Caution: Use of controls or adjustments or performance of procedures other than those specified herein may result in hazardous radiation exposure.

Wavelength: 650nm

Beam divergence: horizontal: 41°, vertical: 26.5°

Pulse duration and repetition rate: 16.8mSec

Maximum power or energy output: 1mW

Attention: L'utilisation des commandes ou réglages ou l'exécution des procédures autres que celles spécifiées dans les présentes exigences peuvent être la cause d'une exposition à un rayonnement dangereux.

La longueur d'onde: 650nm

La divergence du faisceau: horizontal: 41°, vertical: 26.5°

La durée et fréquence de répétition des impulsions:
16.8mSec

L'émission maximale de puissance ou d'énergie: 1mW



Illustrate for Party site number 573139:

Party site number means that the Factory which manufactured this Fully-Rugged Tablet PC model R8

Factory Information:

Factory Name: TWINHEAD INTERNATIONAL CORP

Factory Address:

31 HUAXI RD

DALIAO DISTRICT

KAOHSIUNG 831 TW

CAUTION FOR ADAPTER

THE TABLET PC IS FOR USE WITH DEDICATED AC ADAPTER.

BATTERY SAFETY

DANGER OF EXPLOSION IF BATTERY IS INCORRECTLY REPLACED.

REPLACE ONLY WITH THE SAME OR EQUIVALENT TYPE RECOMMENDED BY THE MANUFACTURER. DISPOSE OF USED BATTERIES ACCORDING TO THE MANUFACTURER'S INSTRUCTIONS.

CAUTION FOR RJ-45 (Optional)

The RJ-45 jack is not used for telephone line connection.

Safety Instructions

Always observe these safety instructions to ensure safe operation when handling the device.

- Do not place this device on an unstable table or surface. The device may fall, causing serious damage to its housing and components.
- Do not cover the device or block its air ventilation holes with any other objects.
- Do not use any sharp objects to tap on the display screen.
- Do not expose the device to direct sunlight and dusty environments.
- Keep the device away from excessive heat and humidity.
- Keep liquids away from the device.
- Keep the device away from any magnetic emitting devices, as this may affect the quality of the wireless signal reception.
- When using an AC adapter:
 - ✓ Place this device in a location close enough to an electrical outlet to accommodate the length of the power cord.
 - ✓ Operate this device only with the type of power source indicated on the marking label.
 - ✓ Disconnect the AC adapter from the electrical outlet if the device is not being used for an extended period.
- When cleaning the device,
 - ✓ Be sure to turn off the device fully and unplug the AC adapter before cleaning.
 - ✓ Wipe the device with a clean, dry cloth.
 - ✓ Do not use abrasive cleaners to clean the device.

Appendix

- Do not attempt to disassemble or repair this device. Doing so will void the warranty.
- For hotspots, users can easily avoid touching the device by changing the way the device is held.
- For battery pack:
 - ✓ Replacement of a battery with an incorrect type that can defeat a safeguard.
 - ✓ Disposal of a battery into fire or a hot oven, or mechanically crushing or cutting of a battery, that can result in an explosion.
 - ✓ Leaving a battery in an extremely high temperature surrounding environment that can result in an explosion or the leakage of flammable liquid or gas.
 - ✓ A battery subjected to extremely low air pressure that may result in an explosion or the leakage of flammable liquid or gas.
- The equipment power supply cord shall be connected to a socket-outlet with earthing connection.

ShopFloor Date Code Format Description

Format	Type	Year (unit digit)	Week	Origin	Year (tens digit)	Serial number
Example	SY	0	17	0	1	12345
Date Code	2	1	2	1	1	5
Total code numbers	12					

Definition of the Date Code

First Date Code: Type

SY ... System (complete machine)

Second Date Code: Year (unit digit)

Last digit of the calendar year. Example: 2010 "0", 2015 "5"

Third Date Code: Week

Week of the calendar year. Example: January 1 "1", January 8 "2"

Fourth Date Code: Origin

0 ... Main Factory (Twinhead International Corp.)

Fifth Date Code: Year (tens digit)

Tens digit of the calendar year. Example: 2010 "1", 2023 "2"

Sixth Date Code: Serial number

Unique 5-character sequence number assigned to the batch.

