

RTC-I101

User's Manual



With Microsoft Windows 10/11

Table of Contents

- 1. About this Manual2**
 - 1.1 Introduce 2
 - 1.2 Precautions and Safety..... 2
 - 1.3 Recycling and Disposal Instructions..... 3
 - 1.4 Regulatory Information..... 3
 - 1.5 Product Application Scenario 3
- 2. Product Overview.....5**
 - 2.1 RTC-I101 5
 - 2.2 Appearance View 6
 - 2.3 System specification parameter 9
- 3. Function Use 13**
 - 3.1 Key Operation..... 13
 - 3.2 Wireless Network..... 15
 - 3.3 Bluetooth (Win 10) 17
 - 3.4 4G (Win10) 21
 - 25
- 4. Accessories and Power 34**
 - 4.1 Check the packing 34
 - 4.2 Power connection 35
- 5. Battery Description 37**
 - 5.1 Power Adapter 37
 - 5.2 Battery Pack 37
- 6. Product Maintenance 40**
 - 6.1 Protective Tablet 40
 - 6.2 Flat Maintenance 40
 - 6.3 Carry it on long trips..... 42
- 7. FAQ & Warranty 44**
 - 7.1 Preliminary Inspection Items 44
 - 7.2 Reboot..... 44
 - 7.3 Warranty and After-sales Service..... 44

Chapter 1. About this Manual



1. About this Manual

1.1 Introduce

This is the user manual of RTC-I101, which mainly includes the introduction of the application environment of the product, Appearance description, product characteristics, technical parameters, common function Settings, machine installation, precautions and after-sales common problem diagnosis. This manual is designed to help users solve problems encountered in the process of use, In order to better use RTC-I101, please be sure to read this manual in detail.

1.2 Precautions and Safety

- Before using the RTC-I101, be sure to read the tablet's manual carefully and follow the instructions.
- Do not exert excessive pressure or impact on the screen; otherwise, the LCD panel may crack, causing personal injury. If the liquid crystal panel is damaged and leaks, do not touch the liquid inside, because the liquid will irritate the skin.
- Although the terminal is tested to IP67 standards for water and dust resistance, it is exposed to rain or other concentrated moisture for long periods of time. This situation exceeds IP67 standards and can result in water or other contaminants entering the terminal.
- Use only the original standard AC/DC adapter on the terminal. Using AC/DC adapters that do not meet the standards can cause electrical problems and even cause fires or electrical failures.
- Do not disassemble the terminal. Maintenance should be carried out by the supplier. If the terminal or accessories are damaged due to faulty operation or unauthorized repair, the warranty is void. If the warranty seal is damaged, the warranty is void.
- Back up all important data regularly.
- In no event shall Supplier be liable for any direct, indirect, consequential or incidental damage and/or any loss of data arising from the use or inability to use the hardware and software, even if Supplier has been advised of the possibility of such damage.

1.3 Recycling and Disposal Instructions



Do not throw away products with this logo or discard them in the trash.



1.4 Regulatory Information



If you need CE, FCC, RoHS and other documents that meet the requirements, please consult the contact window of Darveen Tablet.。

1.5 Product Application Scenario

RTC-I101 is an 10-inch rugged tablet launched by Darveen for the military three-defense industry, equipped with Intel Celeron high-performance processor, the main frequency is up to 2.8GHZ, pre-installed Windows operating system, so that it can better adapt to the application in industrial automation control. The three-guard plate can be embedded in the machine, cabinet or on the operating table to achieve human-computer interaction, and is the best platform for various industrial control, traffic control, environmental control and other applications in the field of automation. Such as automation control, traffic control, vehicle, monitoring, self-service terminals, electronic terminals, information systems, vision systems, measurement and control, Marine systems, environmental control, environmental testing, network security, logistics, express management and other application platform management.

Chapter 2. Product Overview



2. Product Overview

2.1 RTC-I101

Congratulations on your purchase of RTC-I101, RTC-I101 is an 10-inch rugged tablet launched by Darveen for the military three-defense industry, Powered by Intel Celeron high performance processor, The main frequency is up to 2.8GHZ, Pre-installed Windows operating system, Take full advantage of Microsoft Windows data processing capabilities in a mobile environment, optimize application and network management capabilities, while maintaining the flexibility of multitasking applications. RTC-I101 adopts industrial high-brightness capacitive touch screen, protection level IP67, meet 1.22m fall prevention, a variety of wireless communication methods, support 4G LTE, WIFI, BT, GPS and other communication, long endurance time, built-in large-capacity lithium battery, battery removable. Optional modules: 1D/2D scanning code, RFID UHF, NFC, ID card (second generation), fingerprint recognition and so on.

- Equipped with Intel N5100 high-performance processor, the main frequency is up to 2.8GHZ,
- 10 inch brightness 700cd/m² high-light capacitive touch screen
- IP67 protection grade, meet 1.22m fall prevention
- A variety of wireless communication modes, support 4G LTE, WIFI, BT, GPS and other communication
- Long standby, built-in large capacity lithium battery, battery removable
- Optional modules: 1D/2D scanning code, RFID UHF, NFC, ID card (second generation), fingerprint recognition

2.2 Appearance View

Front component



Bottom component

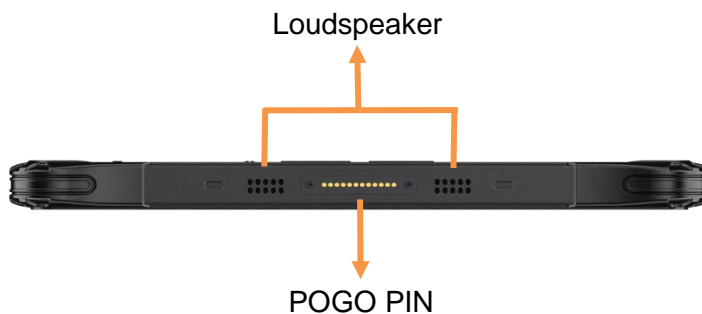

Back-end component

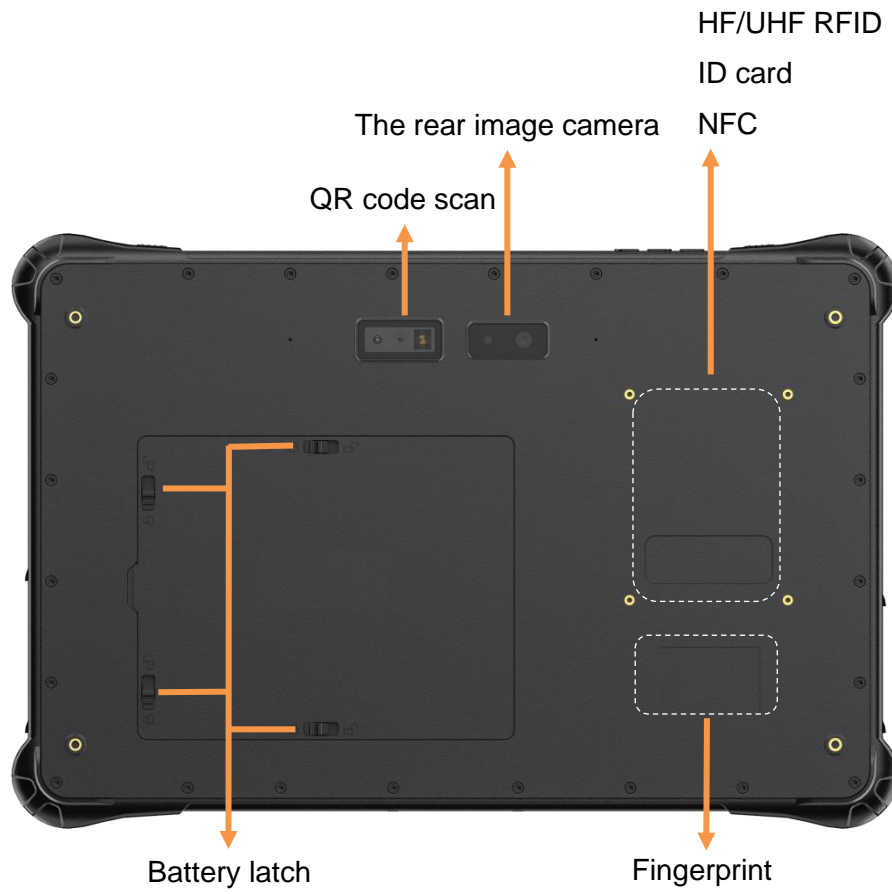

Top component

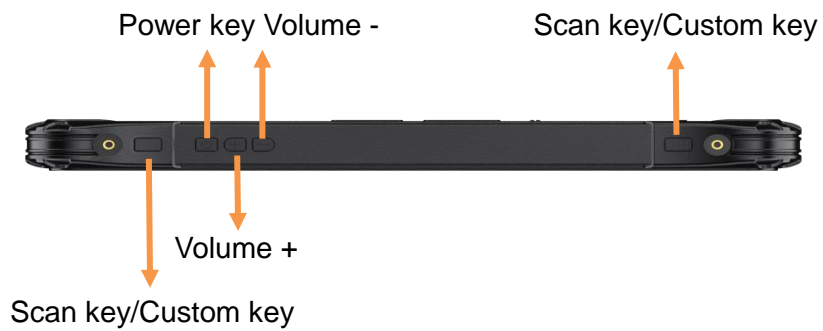

Right side component

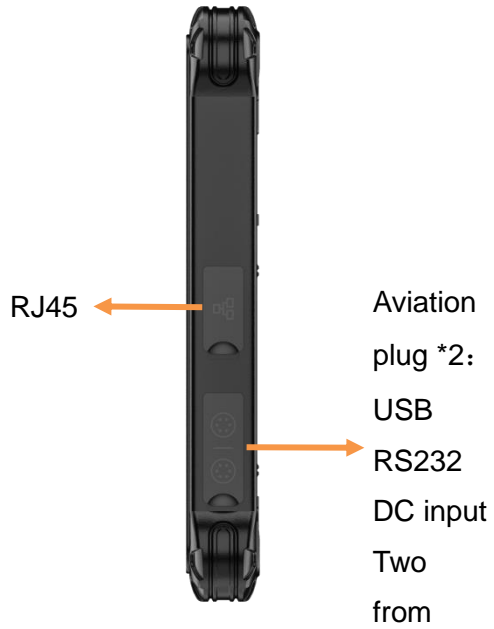

Left side component

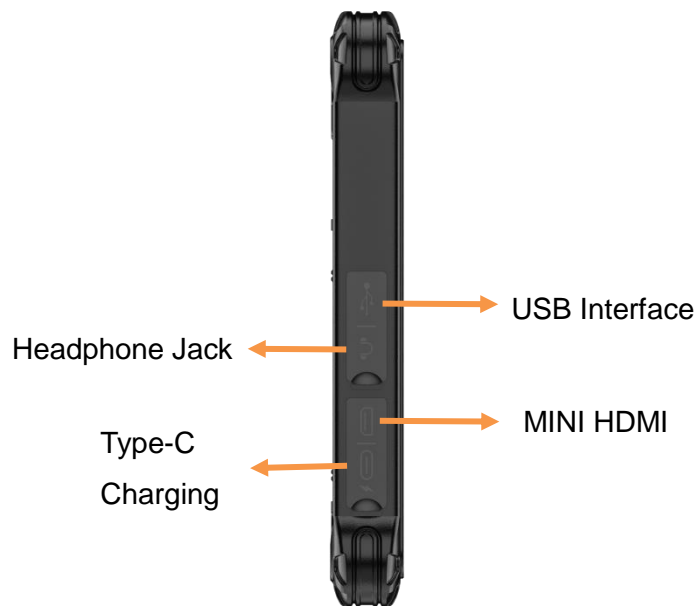

2.3 System specification parameter

The specifications of the RTC-I101 are as follows. Unless otherwise specified, all specifications are subject to change without prior notice.

Basic parameter	Apparent dimension	236.5 * 156.7 * 23mm
	Weight	900g
	Color	Black
	Display screen	10 inch 16:10 TFT IPS, resolution 800*1280(optional 1200*1920), Brightness 700cd/ m ²
	Touch screen	Multi-touch capacitive touch screen, G+G, Gorilla glass, hardness 7H
	Camera	Front 5MP prime camera, rear 8MP autofocus camera with flash
	Loudspeaker	8Ω/1W, Stereo dual speakers
	Battery	Removable polymer lithium-ion battery, 7.6V 5000mAh
	Endurance time	8 hours (default 50% brightness for 1080P video playback)
System configuration	CPU	Intel Jasper Lake N5100 processor, 4 cores, 4 threads, embedded 4 MB SmartCache, maximum CPU frequency 2.8GHz
	GPU	Intel HD Graphics Gen 11 LP
	RAM	4GB DDR4 (selectable 8GB)
	ROM	64GB M.2 NGFF (selectable 128GB)
	Sensor	Gravity acceleration sensor
Network configuration	WIFI	WIFI 5 802.11ac Frequency 2.4G+5G Dual-frequency WIFI
	Bluetooth	BT4.2 (BLE) class1 , Transmission distance : 10m

	4G	LTE-FDD: B1/B3/B5/B7/B8/B20/B28 LTE-TDD: B34/B38/B39/B40/B41 WCDMA/HSPA+:B1/B5/B8
	GPS	GPS、GLONASS、Beidou(G+G+B)
Software configuration	Operating system	Windows 10(selectable 11 version)
Data acquisition	NFC	13.56MHz support ISO/IEC 14443A/14443B/15693/18092/MIFARE agreement ,Card reading distance 0 ~ 1.5 cm
(Optional)	RFID	High frequency 13.56MHZ,support ISO/IEC 14443A/14443B/15693 agreement ,Super high frequency PR9200 / R2000
	QR code scan	Optical resolution: 5mil, scanning speed :50 times /s
	ID card	Second generation ID card module
	Fingerprint	Ministry of Public Security authentication/FBI authentication fingerprint module
I/O Interface	TF	TF Card holder *1 , Supports up to 2TB
	SIM	Micro SIM Card holder *1
	USB Type-C	Type-C *1, Charging
	USB Type-A	USB 3.0 *1
	Headphone Jack	Standard 3.5mm interface *1
	HDMI	Mini HDMI 1.4a *1
	Ethernet	RJ45 *1 ,10/1000M
	Pogo Pin	Bottom 12Pin *1(Charging interface, USB signal connection base)
Aviation port	Aviation port *2 (Optional): USB、RS232、 DC power input (two from three)	

Buttons and indicators	Function key	Function key *2
	Power key	Power key *1
	Volume key	Volume + *1, Volume - *1
	indicator	Charging LED indicator *1
Protection configuration	Drop height	1.22m composite wood floor Power-on state
	protection	IP67
	Operating	-10 °C ~ 50 °C
	Storage	-20 °C ~ 60 °C
	Electrostatic	± 5kV Contact discharge 、 ± 10kV Air discharge
	Humidity	95% condensation free

Chapter 3. Function Use

3. Function Use

3.1 Key Operation

3.1.1 Start the RTC-I101

Press the power button to turn on RTC-I101. If RTC-I101 does not power on, check whether the power supply is normal Connect and try again.



When the RTC-I101 is powered on, after the operating system starts, an Windows startup LOGO will appear on the screen for a short time, and then enter the Windows desktop



LOGO of Windows startup

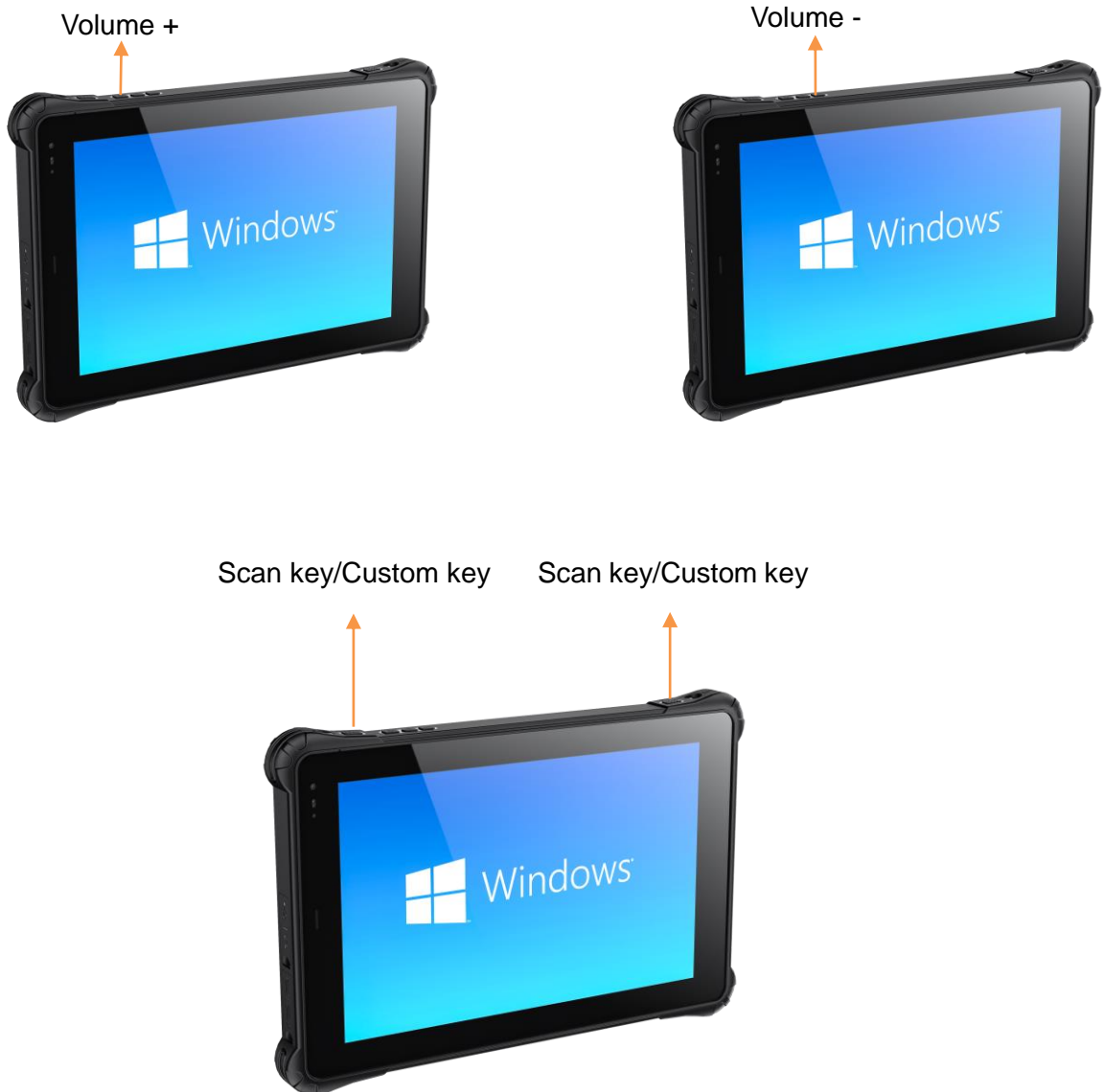

3.1.2 Volume Adjustment and Scan Key/Custom Key

After the RTC-I101 is powered on and the Windows operating system is opened, you can manually adjust the volume and manually set the code scan/Custom key by pressing the buttons on the top of the RTC-I101



3.1.3 Shutdown

When you're done, you can turn off the power or put the tablet to sleep

1	Power off	Click  →[Power]→[Shutdown]
2	Sleep	Use any of the following methods: <ul style="list-style-type: none"> ● Tap the power button. ● Click  →[Power]→[Sleep]
3	Wake up	When the screen is blank, tap [Power button] to wake up the screen.
4	Dormancy	By default, this item does not appear in the [Power menu]. if If you want to use this feature, please go to the Settings of Windows [Power Management] to set it up.

- 「Sleep」 is the default function of the power button. You can change the results produced by the power key through Windows Power Management Settings.

3.2 Wireless Network

3.2.1 WIFI connection

1. Verify that drivers for Wireless modules, such as wireless card Wireless AC-3165, are installed by looking at Device Manager or Programs and Features.

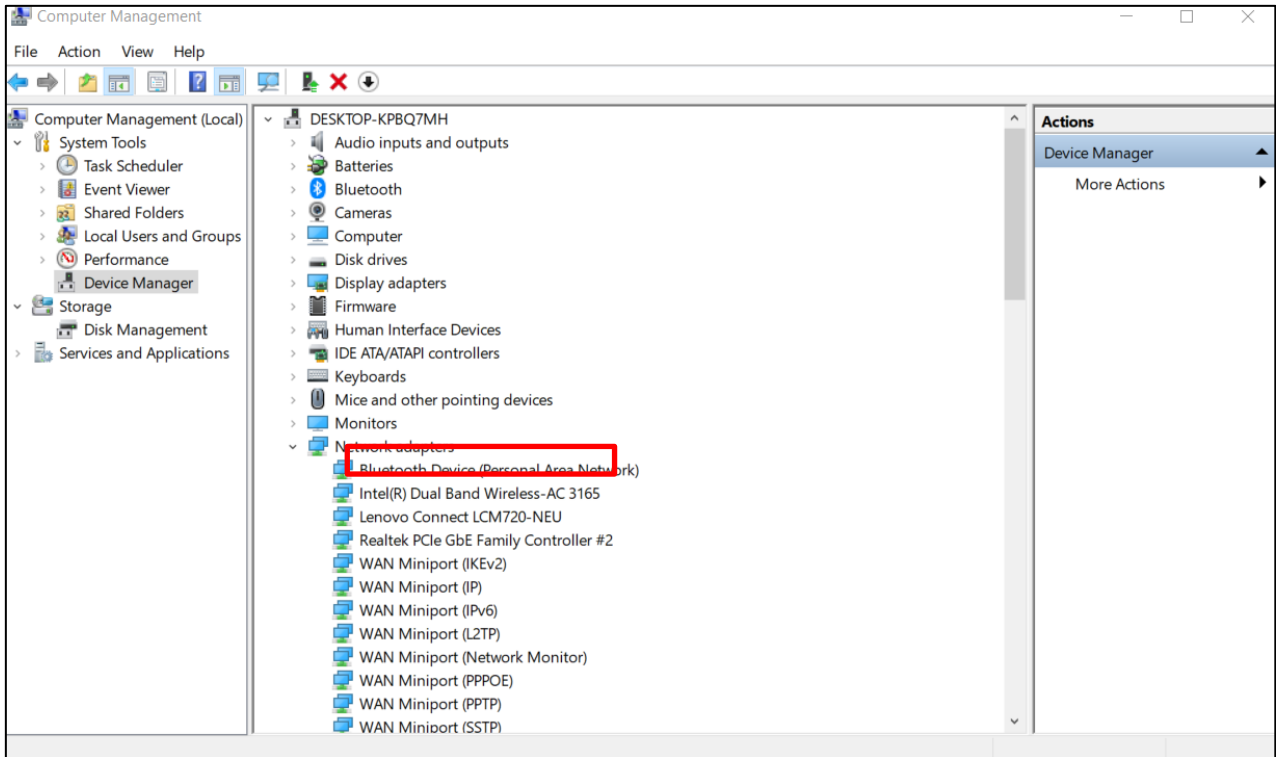

2. Click the network signal icon in the lower right corner of the desktop to view the wireless signal list, select the WIFI signal to be connected, enter the correct password, click Next, check automatic connection, and click OK

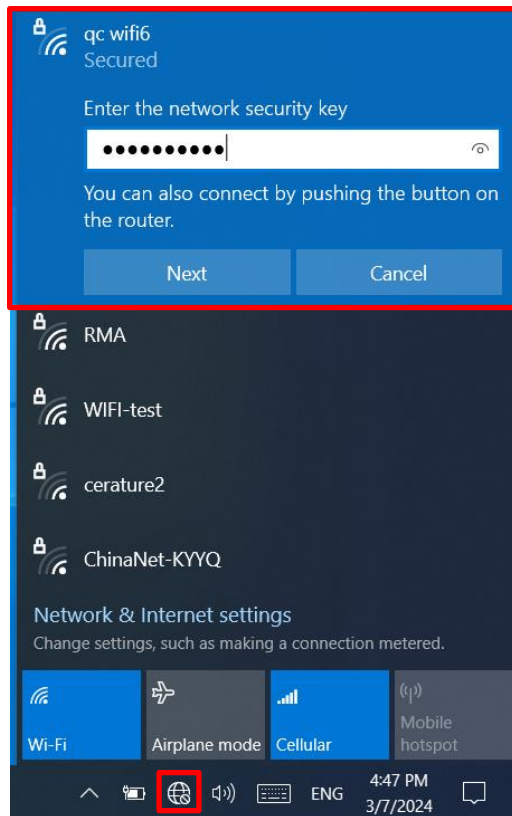

3. The wireless network is properly connected, and you can access the Internet through the wireless network.

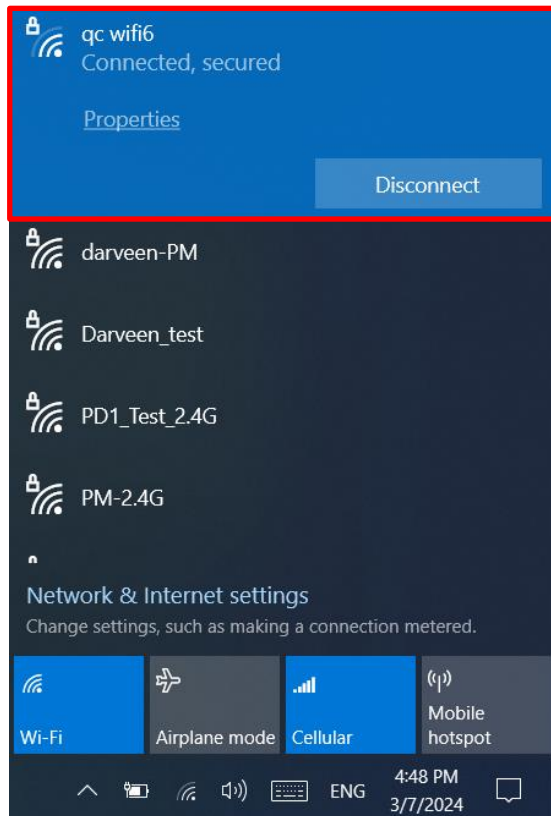

3.3 Bluetooth (Win 10)

3.3.1 Turn on Bluetooth

1. Click the Bluetooth button in the taskbar drawer at the lower right corner of the desktop screen to turn on the Bluetooth device;

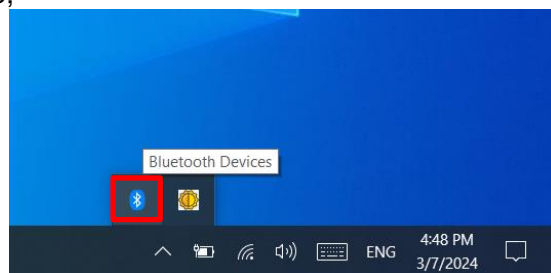

2. Click Bluetooth again to turn on your Bluetooth device and let it be in the discovery state.

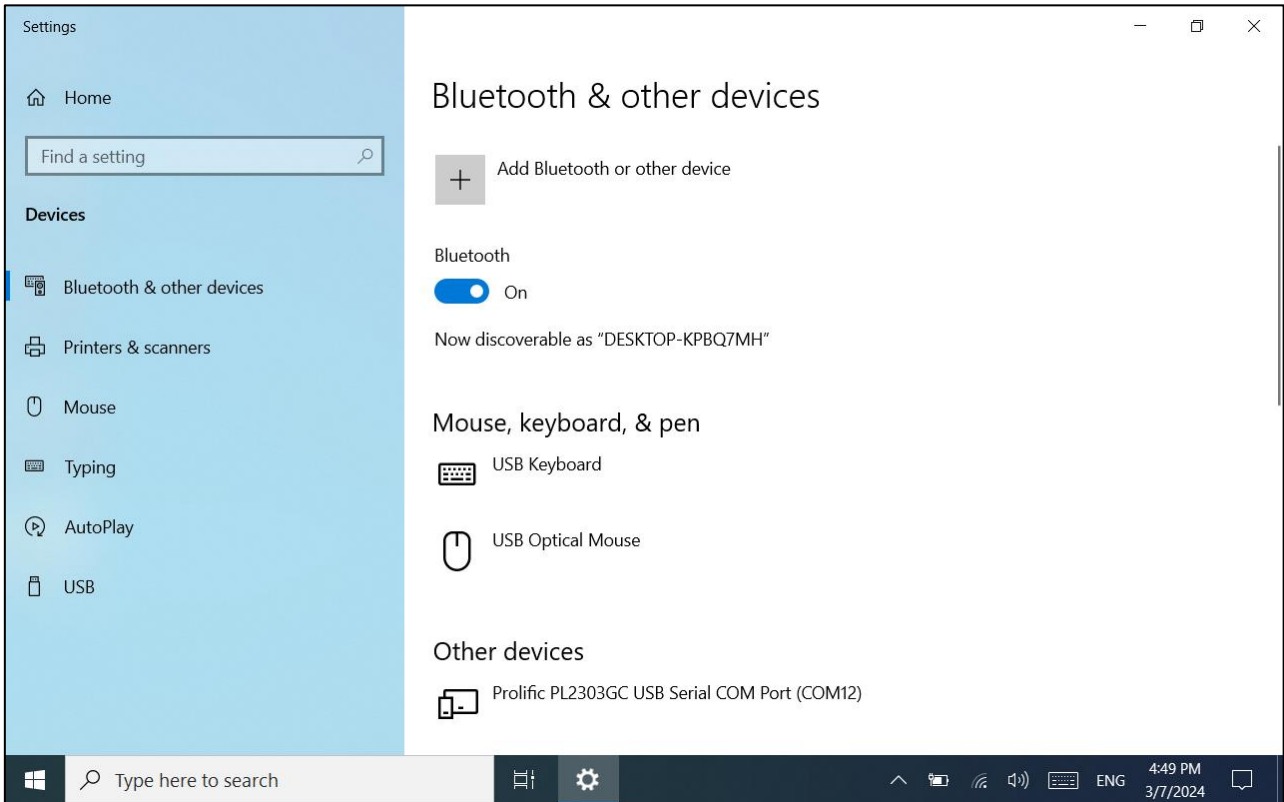

3.3.2 Connect Bluetooth

1. Add the Bluetooth device to be connected;

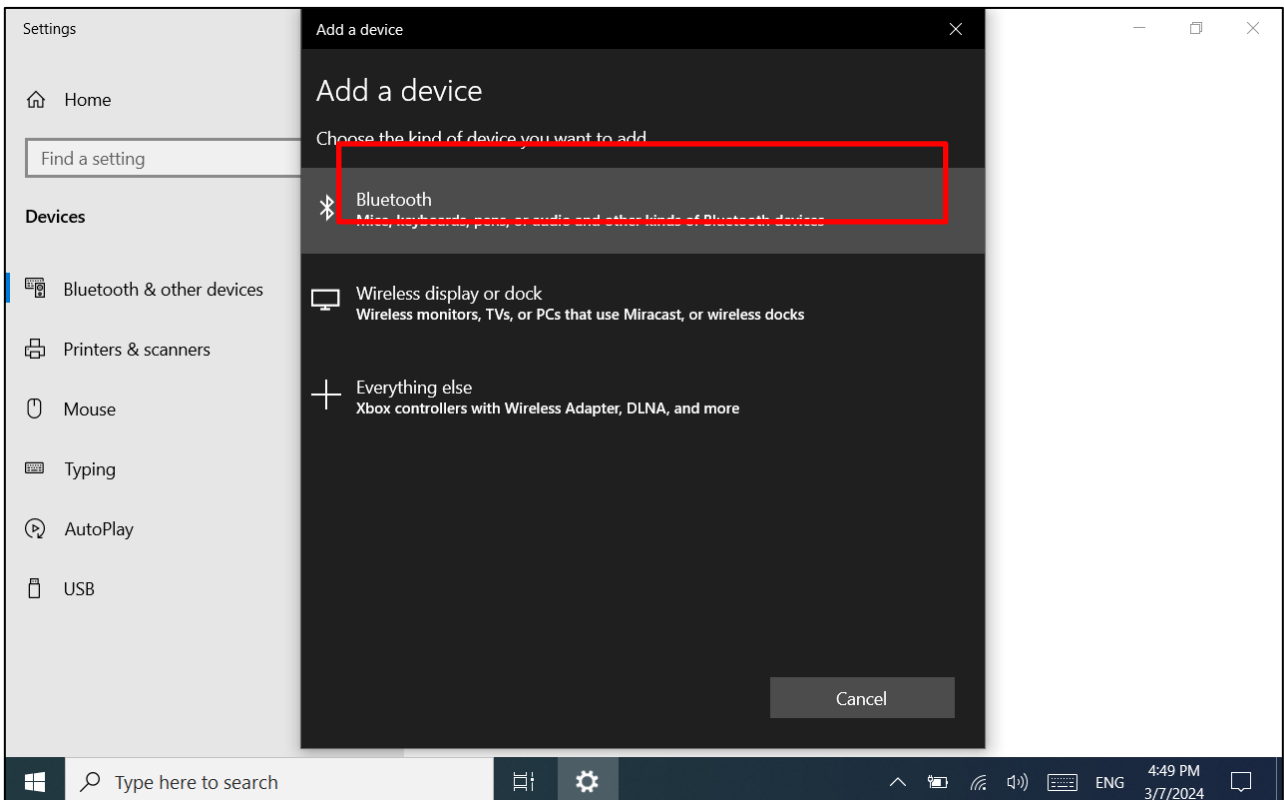

2. For multiple devices, you will see a matching PIN, making sure the RTC-I101 and the password on the device are the same. This can help you ensure that you are connecting your device to the correct machine and not another computer nearby. You need to confirm the connection verification code on the RTC-I101 and other machines;

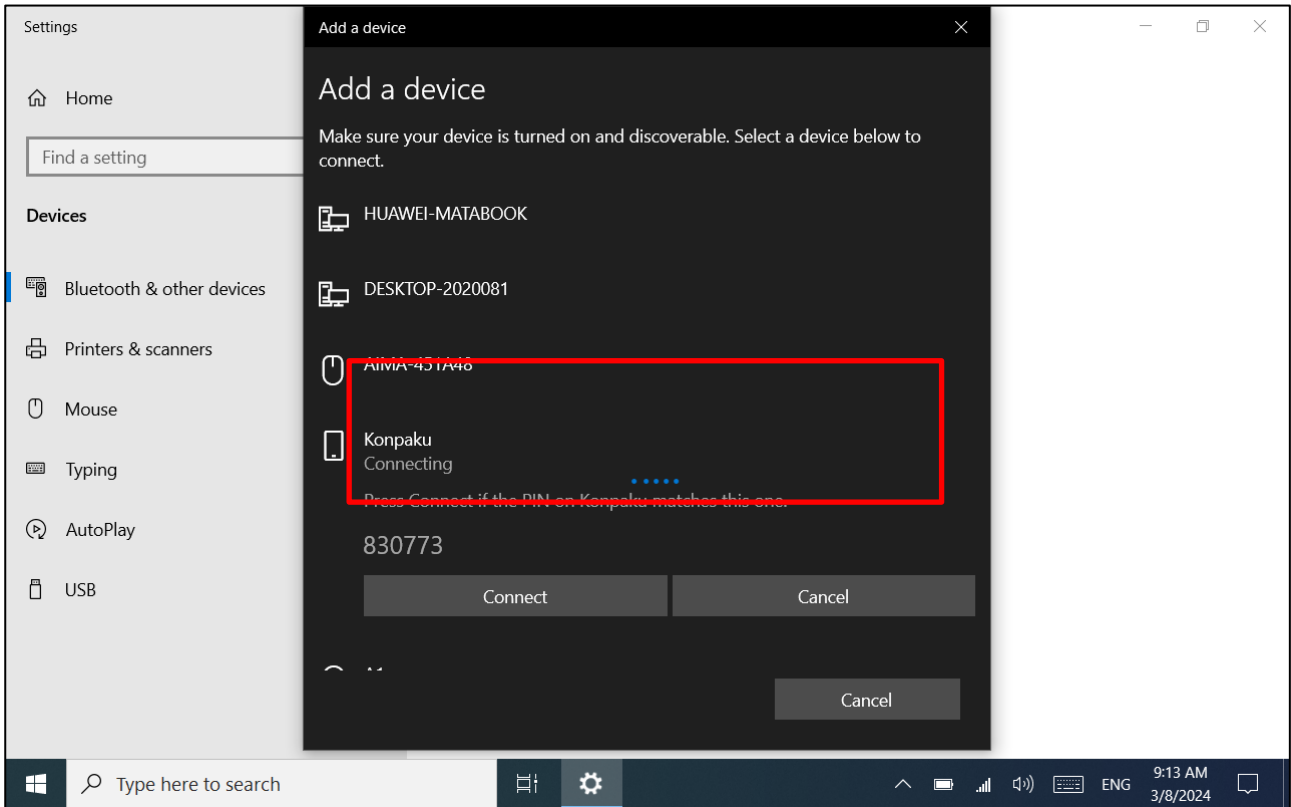

3. Before sending the file to another device, select the following option on the receiving device and wait for the file to be received;

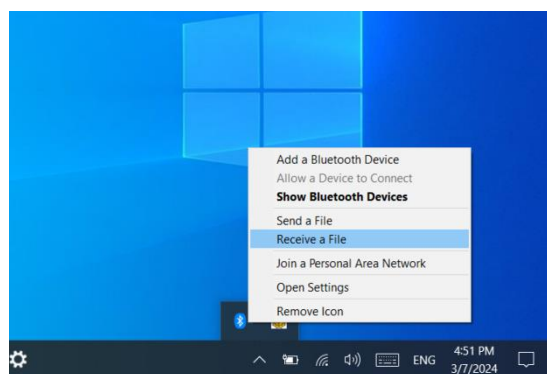

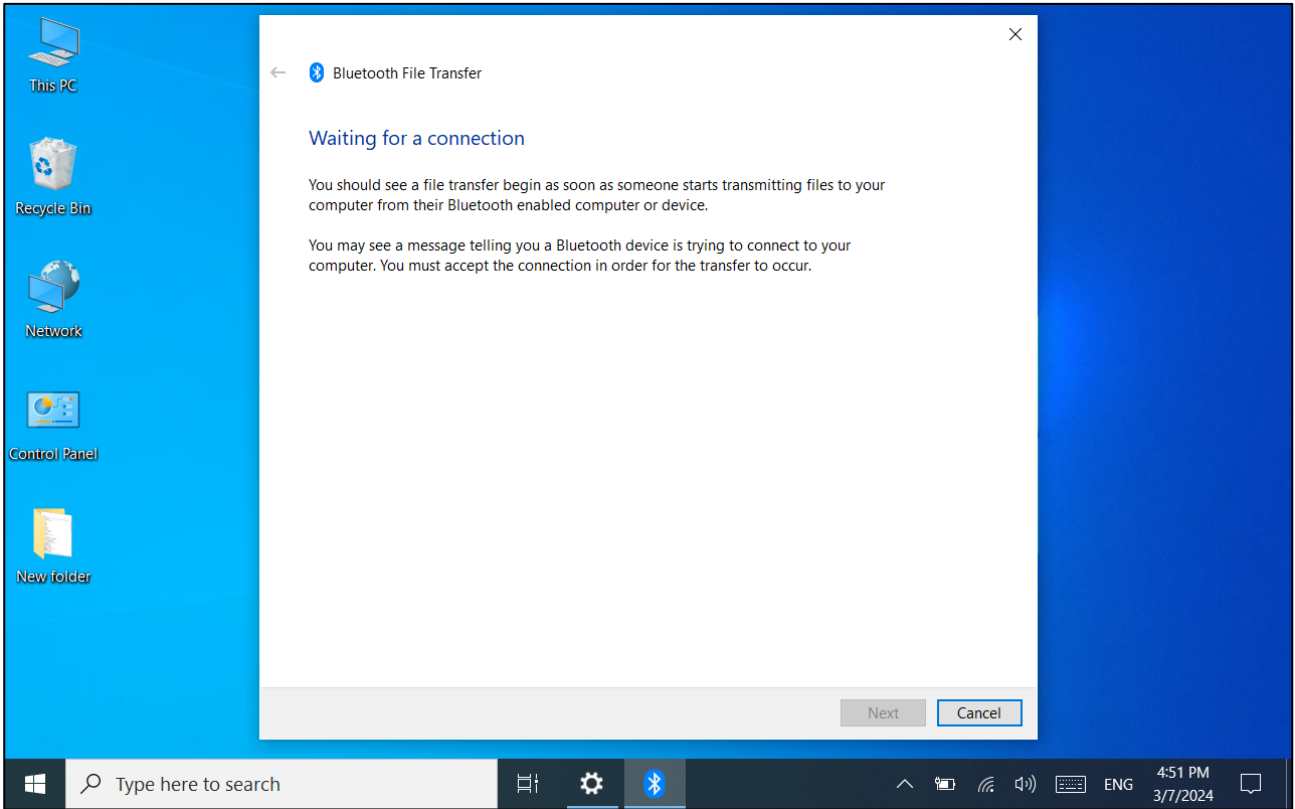

4. RTC-I101 sends files to other devices via Bluetooth;

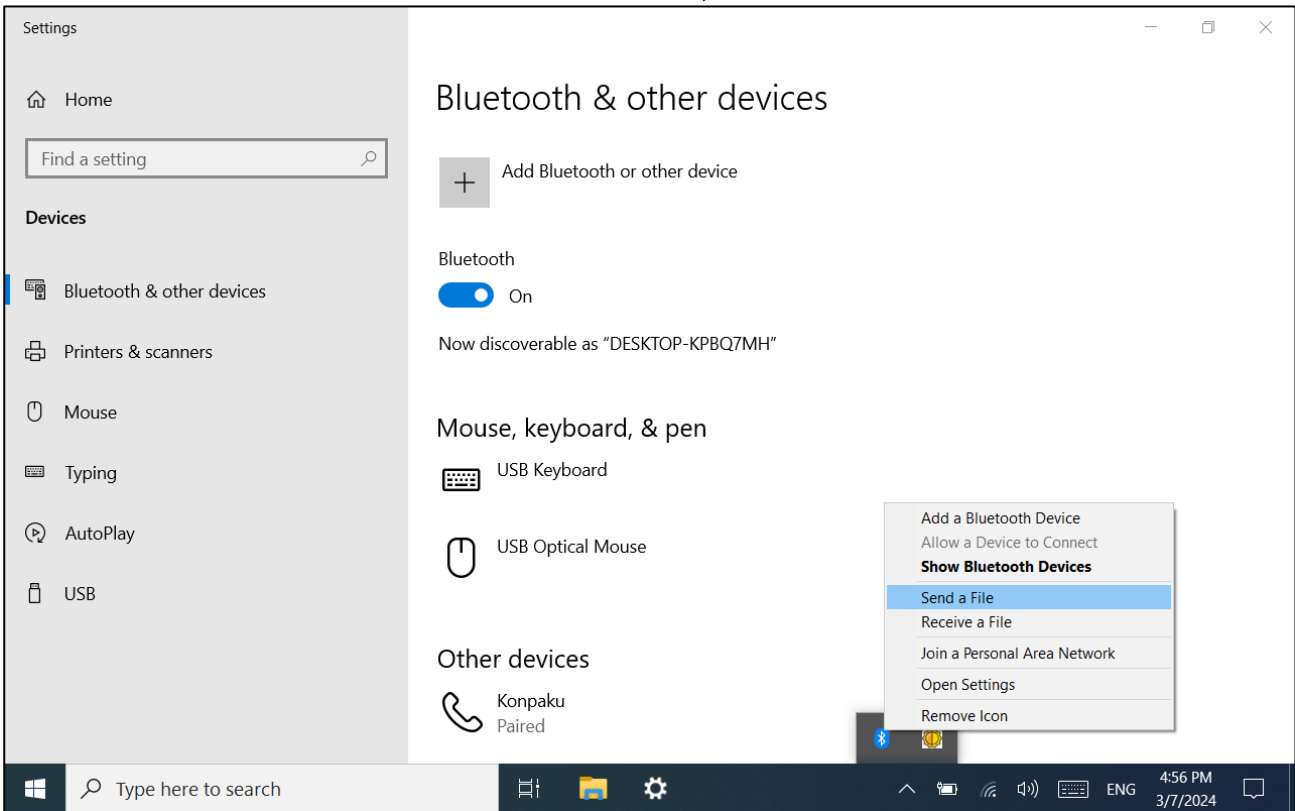

5. Select the device you want to send, click on the device to send the file, and wait for the file to be sent.

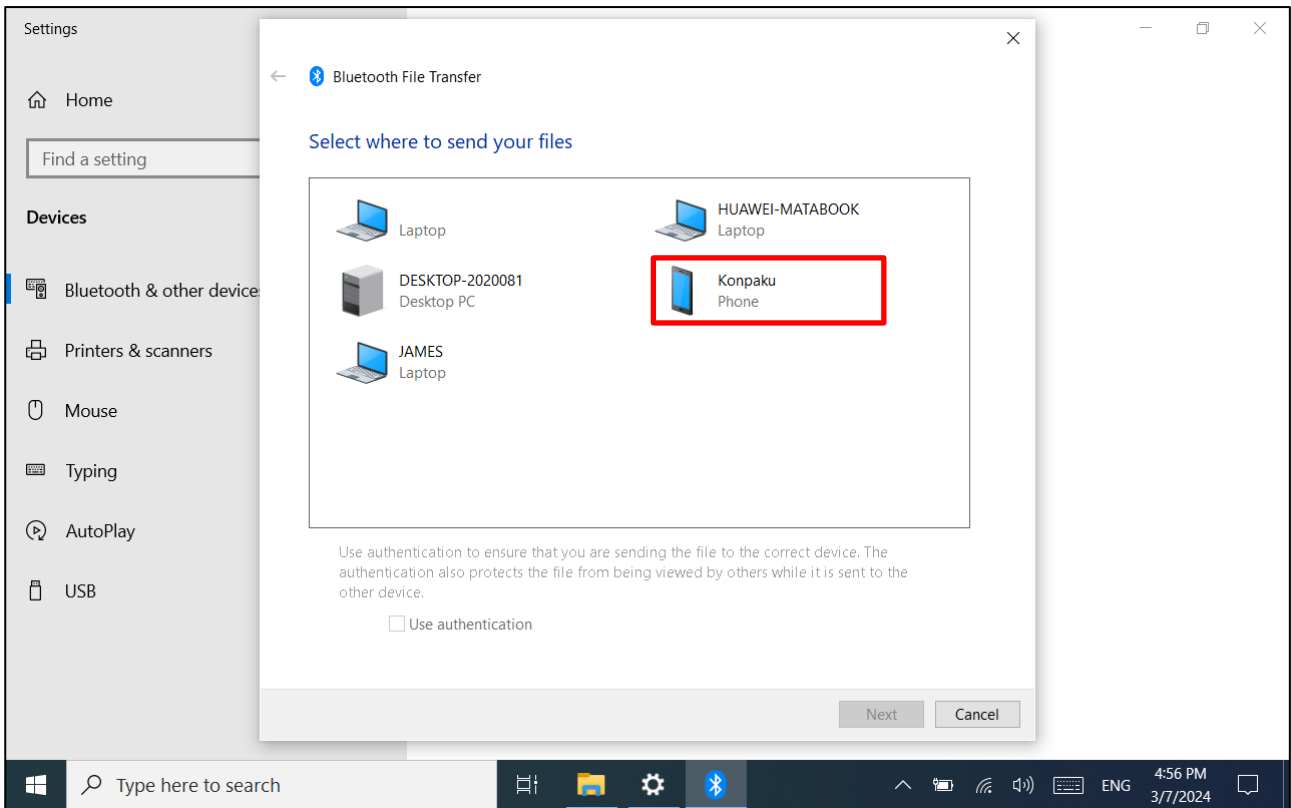

3.4 4G (Win10)

3.4.1 SIM Card Installation

1. Insert the SIM card into the RTC-I101. The SIM card is Micro-SIM size and the SIM card slot is as follows:



2. After the SIM card is installed, if the network connection is normal, the installation is complete. If not, manually enter the APN access point corresponding to the SIM card carrier.

3.4.2 4G Settings



1. After installing the SIM card, check "Let Windows keep me connected" and then click "Network and Internet Settings" to further set the APN, as shown below:

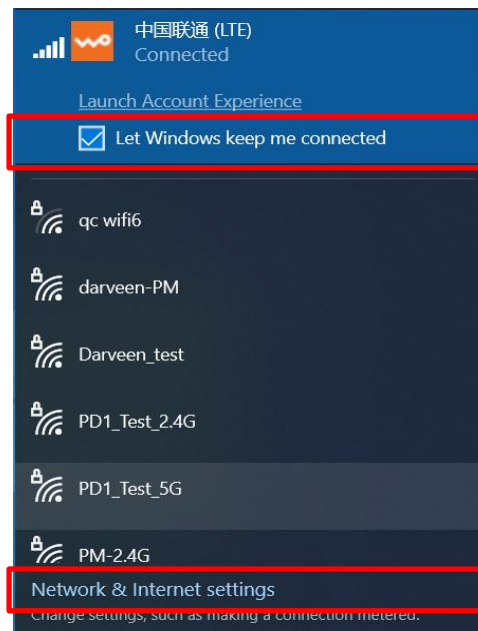

2. Select Mobile Network and click Advanced Options to set the APN.

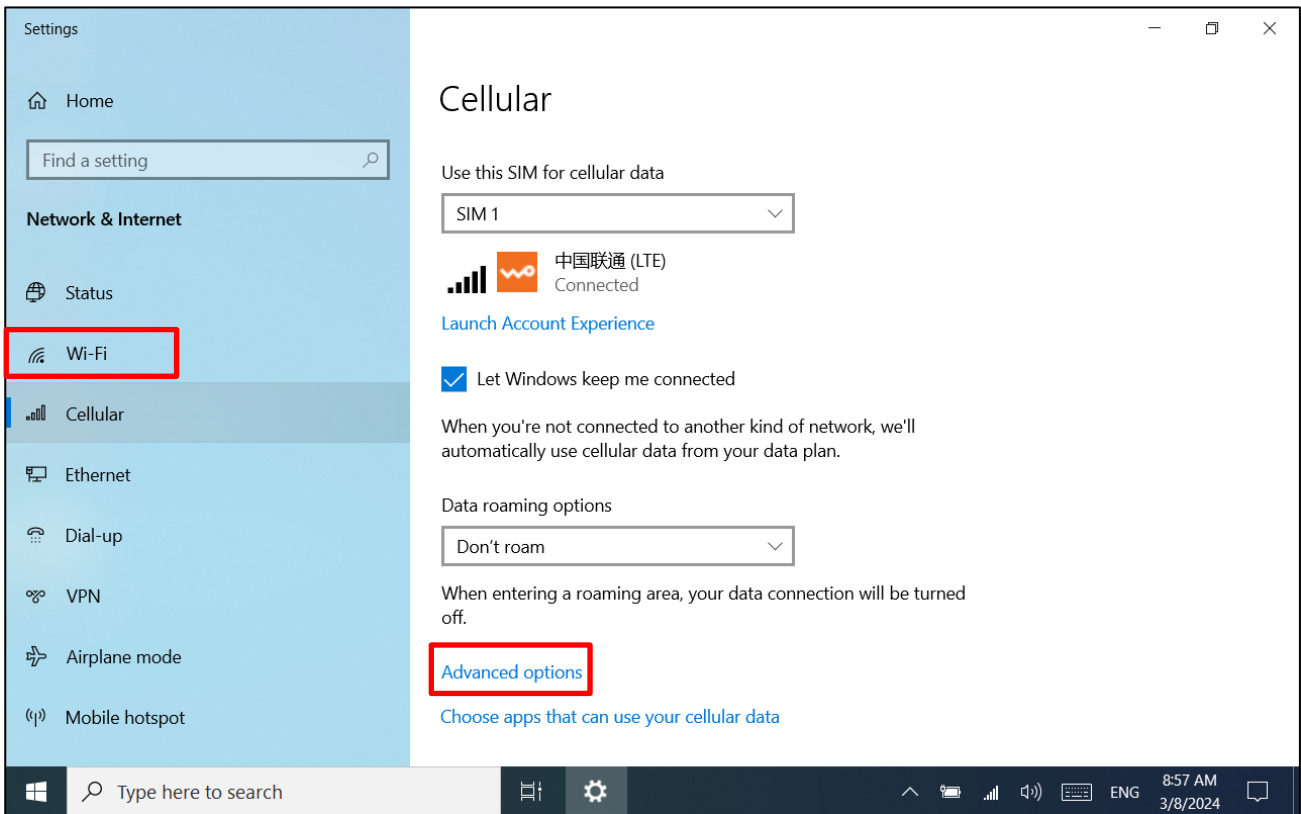

3. After going to "Advanced Options", scroll down to "Access Point Settings" and click "Add Access Point".

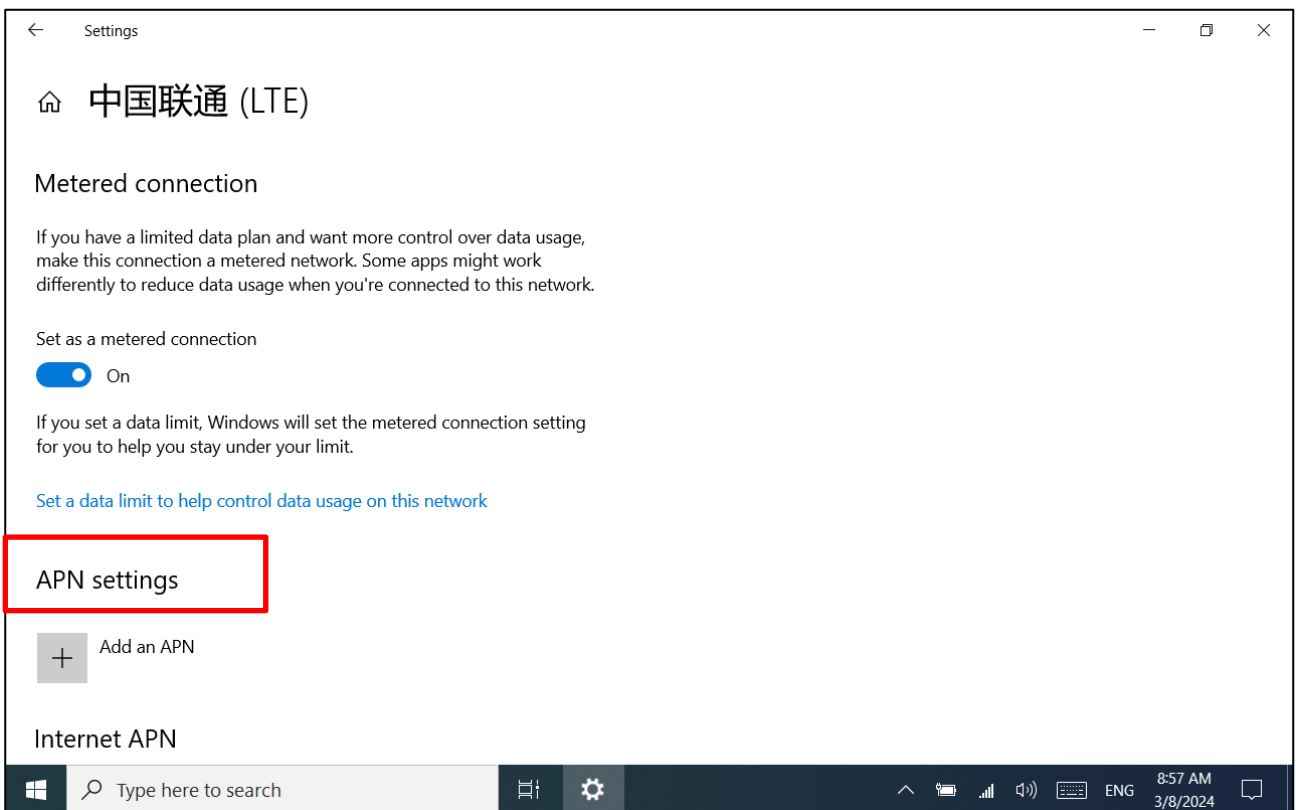

4. The APN of each operator is different, China Mobile is "cmnet", China Unicom is "3gnet", and China Telecom is "ctnet".

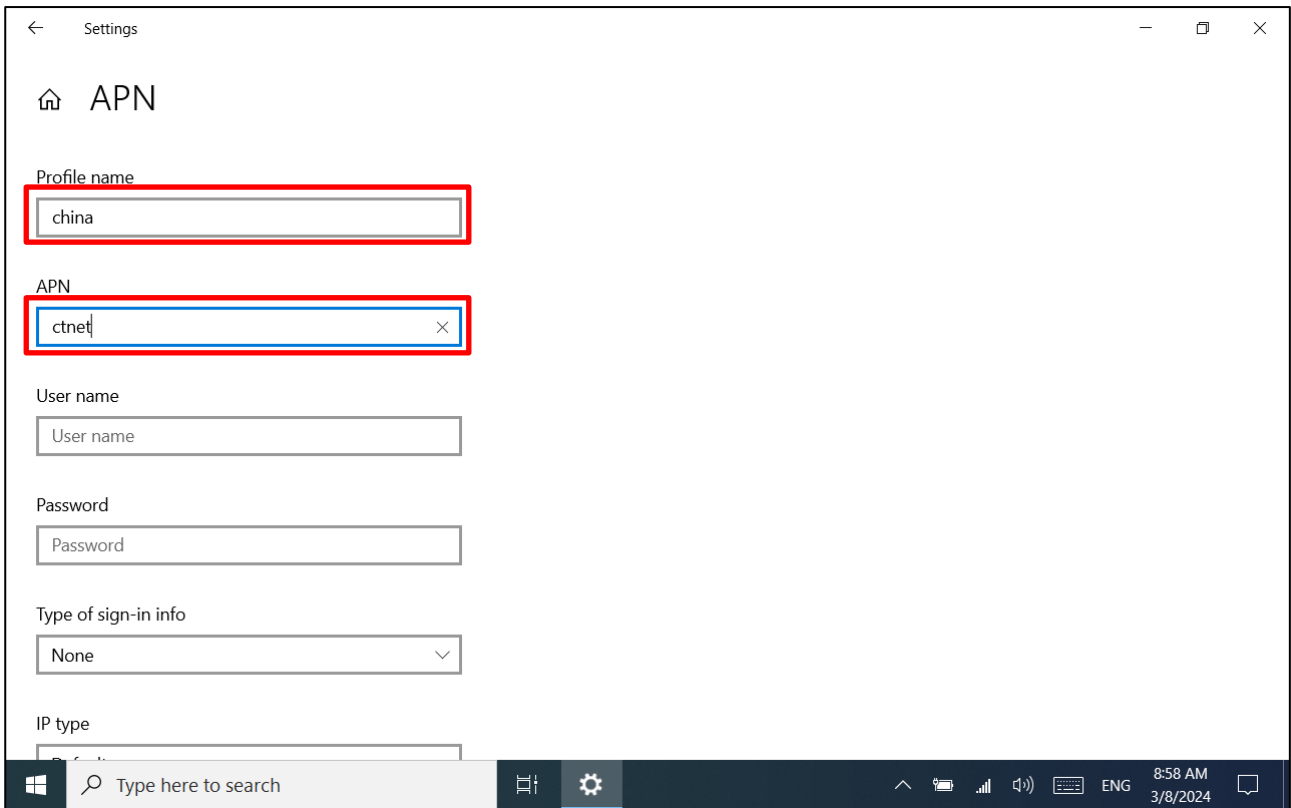

5. After the APN setting is complete, restart the computer, and you can connect to the 4G network and surf the Internet normally.

3.5 GPS

3.5.1 GPS use and testing

1. Install and locate the u-center 8.20 software on the RTC.
2. The u-center 8.20 software startup screen is as follows:

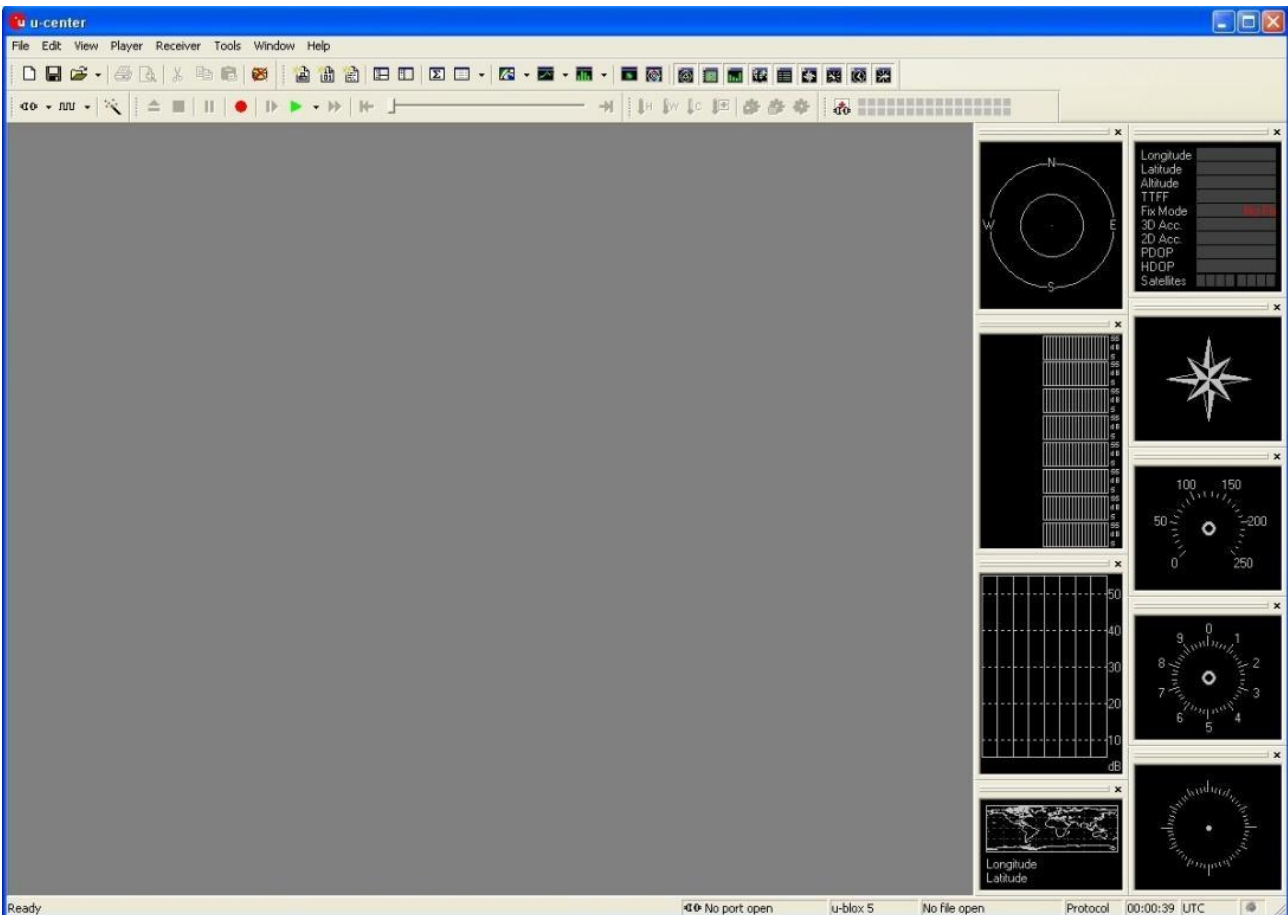

3.5.2 Analysis of GPS information

1. Enter the information display window

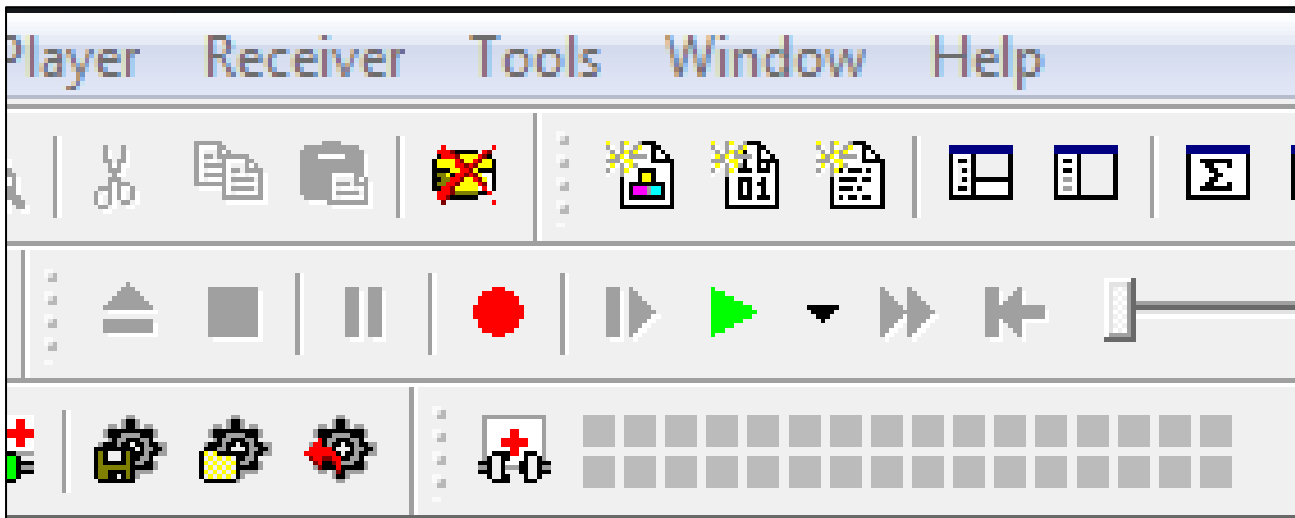

2. The package console lists all incoming messages and provides information about the message length and type.

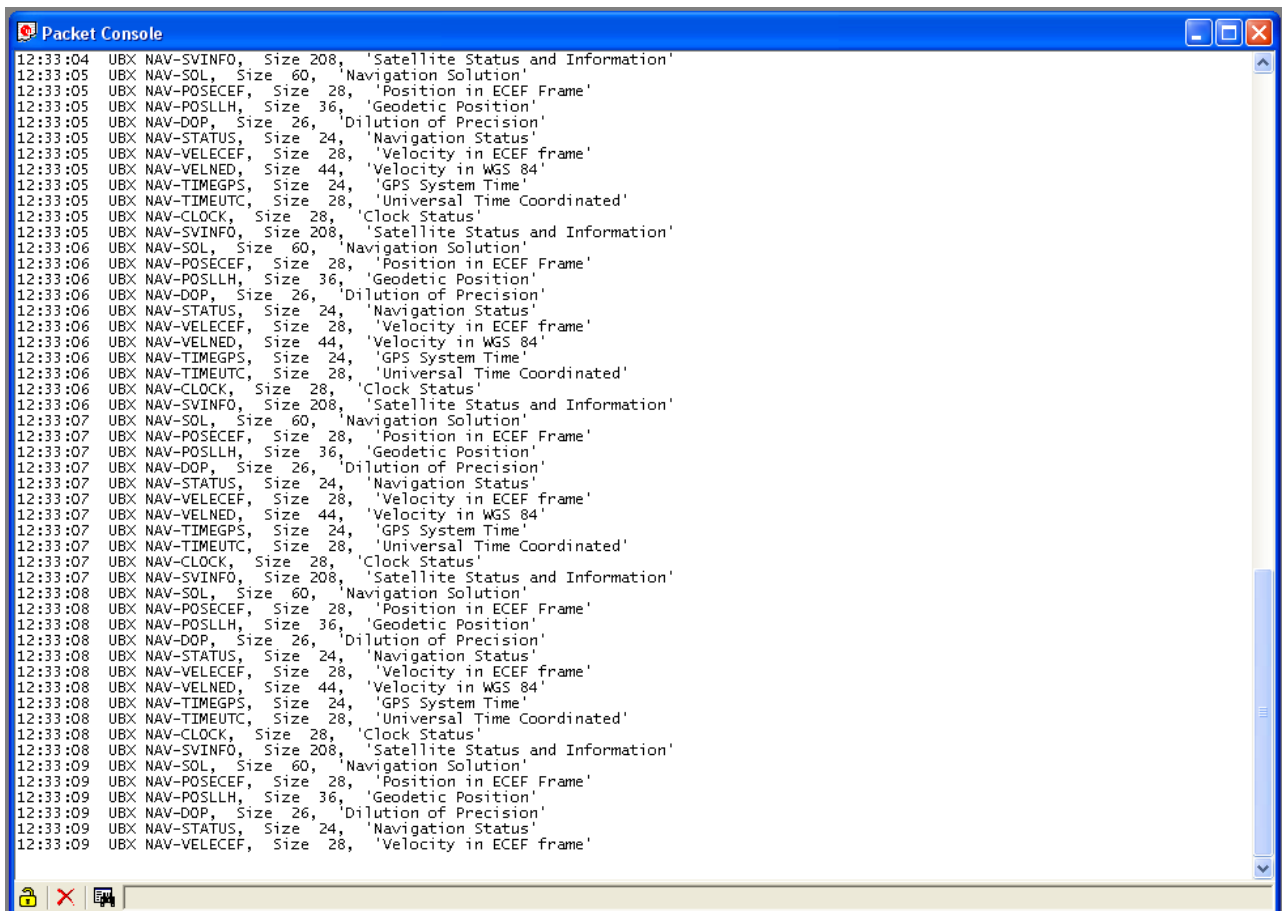

3. The console lists all incoming messages in binary and ASCII formats.

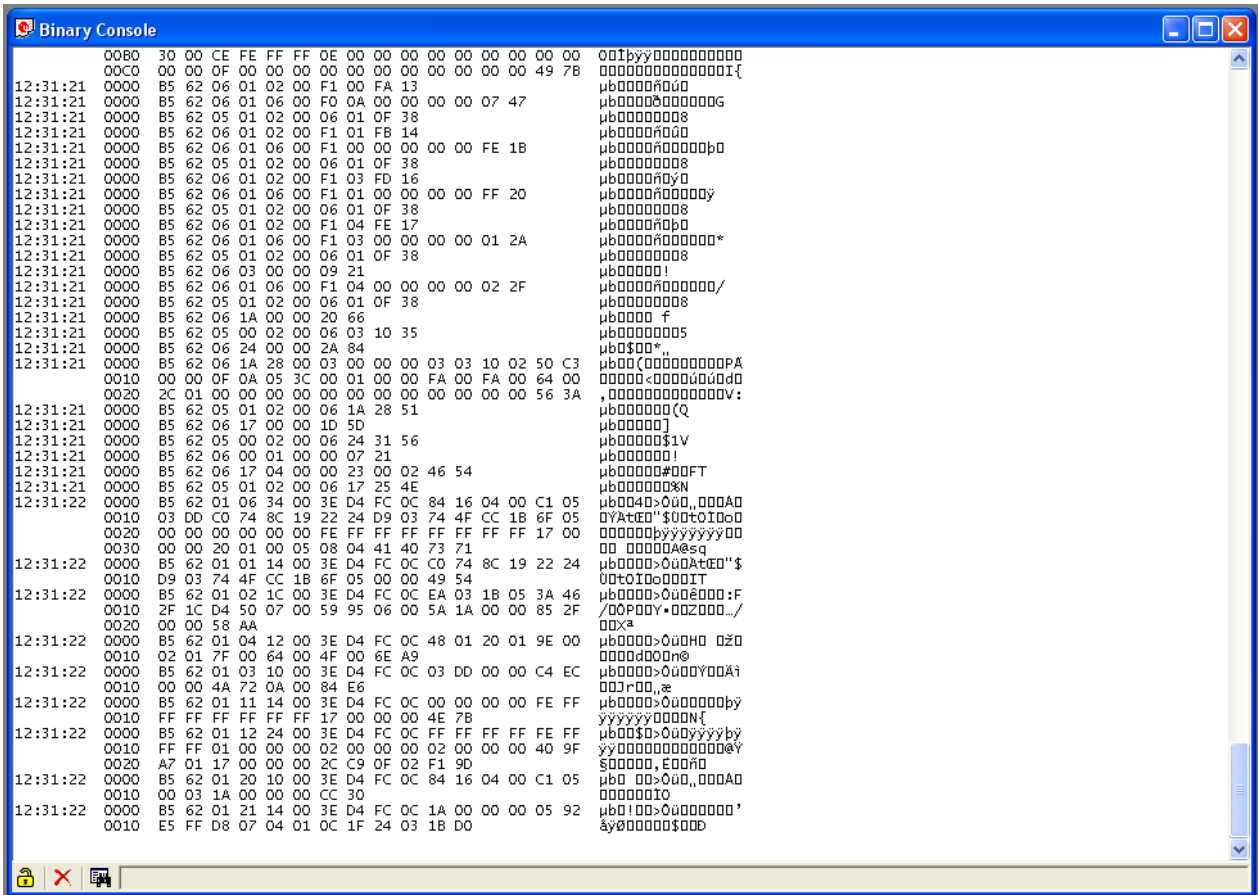

4. The text console displays content messages as text, such as UBX-INF or NMEA messages. The NMEA message is titled \$Gxyyy, where x stands for satellite system (L=GLONASSN=GNSSP=GPS), yyy represents the message type (for example, ZDA=Time & Date).

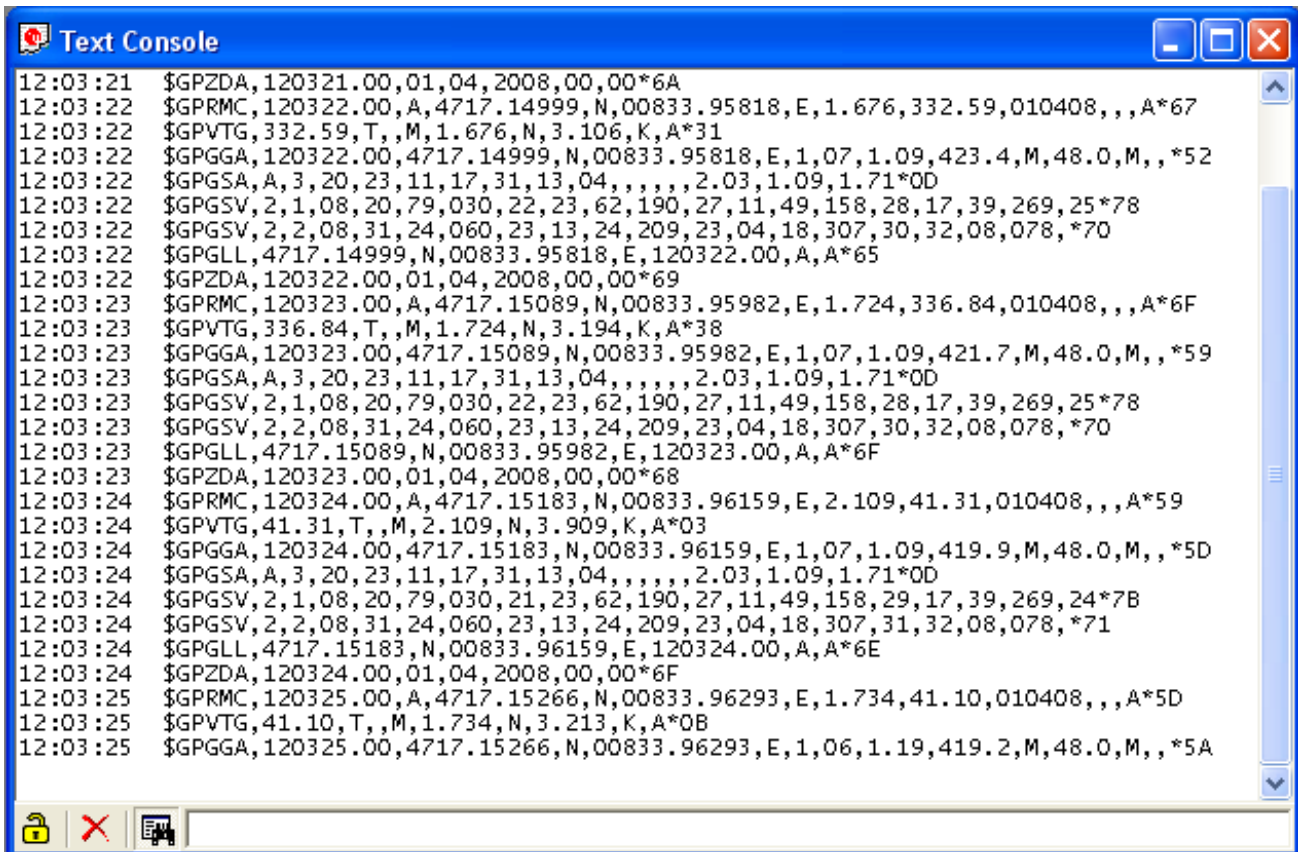

5. Regular expression evaluation

In general, when you search for substrings within a string, the match should be exact. So if we search for the substring "abc", then the searched string should contain these exact letters in the same sequence in order to find a match. We can extend this search to a case-insensitive search where the substring "abc" will look for strings such as "abc", "abc", and so on. That is, case is ignored, but the order of the letters should be exactly the same. Sometimes, case-insensitive search is not enough. For example, if we want to search for numbers, then we basically search each number independently. This is where regular expressions help us. Regular expressions are text patterns used for string matching. Regular expressions are strings of mixed plain text and special characters that indicate the type of match to be performed. Here is a short tutorial on using regular expressions. Suppose that we are looking for a number, then the regular expression we would search for is "[0-9]". The square brackets indicate that the character to be compared should match any of the characters inside the square brackets. A hyphen (-) between 0 and 9 indicates that

the value ranges from 0 to 9. Therefore, this regular expression will match any character between 0 and 9, that is, any number. If we want to search for a special character literally, we must use a backslash before the special character. For example, a single-character regular expression "*" matches a single asterisk. The following table provides a brief description of the special characters. Regular expression search is case sensitive.

symbol	Description
^	The beginning of the string. The expression "^A" matches only "A" at the beginning of the string.
[^	The caret (^) next to the left parenthesis ([]) has a different meaning. It is used to exclude other characters inside the parentheses so that they do not match the target string. "[^0-9]" means that the target character cannot be a number.
\$	The dollar sign (\$) matches the end of the string. The expression "abc\$" matches the substring " abc "only if it is at the end of the string.
	The alternating or logical OR character () allows either expression on its side to match the target string. The expression "a b" will match 'a' and 'b'.
.	Point (.) Will match any character.
*	An asterisk (*) indicates that the character to the left of the asterisk in the expression matches 0 or more times.
+	The plus sign (+) is similar to an asterisk, but at least one of the expressions should match the character to the left of the + sign.
?	Question mark (?) Matches the character from the left 0 or 1 times.
()	The parentheses affect the order in which the schema is computed.
[]	Square brackets ([and]) enclosing a set of characters indicate that any contained character can match the target character.

6. Example

Let's assume that the following lines appear in the NMEA console without filtering.

```

14:00:03 $GPGGA,140003.242,4717.1126,N,00833.7862,E,1,06,1.3,543.0,M,,,,0000*09
14:00:03 $GPGLL,4717.1126,N,00833.7862,E,140003.242,A*34
14:00:03 $GPGSA,A,3,06,17,25,22,30,10,,,,,2.9,1.3,2.6*3A
14:00:03 $GPGSV,2,1,07,06,58,062,44,17,52,161,44,25,45,239,44,22,35,301,44*7F
14:00:03 $GPGSV,2,2,07,30,31,123,44,10,17,059,39,01,05,316,*4E
14:00:03 $GPRMC,140003.242,A,4717.1126,N,00833.7862,E,0.03,80.59,010201,,*36
14:00:03 $GPVTG,80.59,T,,M,0.03,N,0.1,K*56
14:00:04 $GPGGA,140004.242,4717.1126,N,00833.7862,E,1,06,1.3,542.0,M,,,,0000*0F

14:00:04 $GPGLL,4717.1126,N,00833.7862,E,140004.242,A*33

14:00:04 $GPGSA,A,3,06,17,25,22,30,10,,,,,2.9,1.3,2.6*3A
14:00:04 $GPGSV,2,1,07,06,58,062,45,17,52,161,44,25,45,239,44,22,35,301,44*7E
14:00:04 $GPGSV,2,2,07,30,31,123,44,10,17,059,39,01,05,316,*4E

14:00:04 $GPRMC,140004.242,A,4717.1126,N,00833.7862,E,0.02,152.96,010201,,*0D
14:00:04 $GPVTG,152.96,T,,M,0.02,N,0.0,K*6B
    
```

In the following example, the character marked red matches the regular expression.

Example 1: Search for RMC and all GGA messages in a valid location "GP(GGA|RMC,.* , a,)"

```

14:00:03 $GPGGA,140003.242,4717.1126,N,00833.7862,E,1,06,1.3,543.0,M,,,,0000*09
14:00:03 $GPRMC,140003.242,A,4717.1126,N,00833.7862,E,0.03,80.59,010201,,*36
14:00:04 $GPGGA,140004.242,4717.1126,N,00833.7862,E,1,06,1.3,542.0,M,,,,0000*0F
14:00:04 $GPRMC,140004.242,A,4717.1126,N,00833.7862,E,0.02,152.96,010201,,*0D
    
```

Example 2: Search for all GSV whose message index is ' 2 'or' 3 "' GSV, . *, [2-3], "

```

14:00:03 $GPGSV,2,2,07,30,31,123,44,10,17,059,39,01,05,316,*4E
14:00:04 $GPGSV,2,2,07,30,31,123,44,10,17,059,39,01,05,316,*4E
    
```

Example 3: Search for all messages starting with \$GP with a "G" in the message identifier, but not in the first position "^ \ \$GP, + g *."

```
14:00:03 $GPGGA,140003.242,4717.1126,N,00833.7862,E,1,06,1.3,543.0,M,,,,0000*09
14:00:03 $GPVTG,80.59,T,,M,0.03,N,0.1,K*56
14:00:04 $GPGGA,140004.242,4717.1126,N,00833.7862,E,1,06,1.3,542.0,M,,,,0000*0F
14:00:04 $GPVTG,152.96,T,,M,0.02,N,0.0,K*6B
```

Example 4: Search for all messages with a checksum of 3 "*3.\$"

```
14:00:03 $GPGLL,4717.1126,N,00833.7862,E,140003.242,A*34
14:00:03 $GPGSA,A,3,06,17,25,22,30,10,,,,,2.9,1.3,2.6*3A
14:00:03 $GPRMC,140003.242,A,4717.1126,N,00833.7862,E,0.03,80.59,010201,,*36
14:00:04 $GPGLL,4717.1126,N,00833.7862,E,140004.242,A*33
14:00:04 $GPGSA,A,3,06,17,25,22,30,10,,,,,2.9,1.3,2.6*3A
```

Chapter 4. Accessories and Power



4. Accessories and Power Connections

4.1 Check the packing

Open the package and inspect all parts for shortages and damage.

The main components are: RTC-I101 three-proof reinforcement plate, power cord, adapter, hand strap

1	RTC-I101 rugged tablet	
2	Power cord	
3	adapter	
4	hand strap	

4.2 Power connection

The power supply must be connected for the first time.

1. Open the waterproof plug of the Type-C port. (Flat front, waterproof plug on left side)



2. The Type-C power cable of the power adapter is inserted into the Type-C port of the tablet.
3. Insert the female end of the power cable into the power adapter and the male end into the power socket.
4. The power outlet supplies power to the panel through an adapter. Now you can power on the tablet.

Chapter 5. Battery Description

5. Battery Description

Your tablet can be powered by an external Type-C power supply or an internal battery pack. This chapter shows you how to effectively use and manage the power supply. For the best battery performance, you should follow the battery usage precautions.

5.1 Power Adapter

NOTE:

- The power adapter only works with your tablet. Misuse for any other purpose may damage the included appliance or adapter.
- The power cable attached to the power adapter meets the specifications of the place of purchase. If you want to use this tablet abroad, please consult your dealer for a suitable power cord.
- When unplugging, do not pull the wire, should hold the plug to pull out.
- Since your tablet runs on direct current, but a power outlet usually provides AC power, the power adaptor's role is to convert the AC power from the power source to the direct current required by the tablet. While connected to the power adaptor, the battery is automatically charged, and the adapter can operate in the voltage range of 100V to 240V AC.

5.2 Battery Pack

- The battery pack is the internal source of power for the tablet and can be charged via a power adapter.
- Note: The time to remove the battery pack is only when the battery is not being charged.**

5.2.1 Battery Charging

- Note: The rechargeable temperature of the battery is between 0 °C and 50 °C.**
- Connect the tablet to the power adapter, and plug the power cord of the adapter into the power socket to charge the battery. At this time, the two battery indicators on the tablet will light red, indicating that charging is in progress. When the battery is fully charged, the battery indicator is green.

When the battery is low, connect the adapter, put the tablet to sleep, or turn off the tablet power immediately.

- Note: Do not unplug and connect the power adapter immediately after the battery is fully charged, as the battery may be damaged.**

5.2.2 Replace Battery Pack

Note:

- Battery replacement errors can cause an explosion. Be sure to use the original battery supplied by the flat plate when replacing the battery. Follow the manufacturer's instructions when discarding old battery packs.

- Do not disassemble the battery pack.

- The battery pack will get hot under prolonged operation. Do not touch the hot battery pack with your bare hands. After removing the battery pack, place it in a well-ventilated place.

- Note: Be sure to turn off the device when replacing the battery so that the device can save the work in progress.

1. Carefully flip the tablet so that the bottom is facing up.
2. Push the four battery door locks to the unlocked position ().
3. Remove the battery pack.

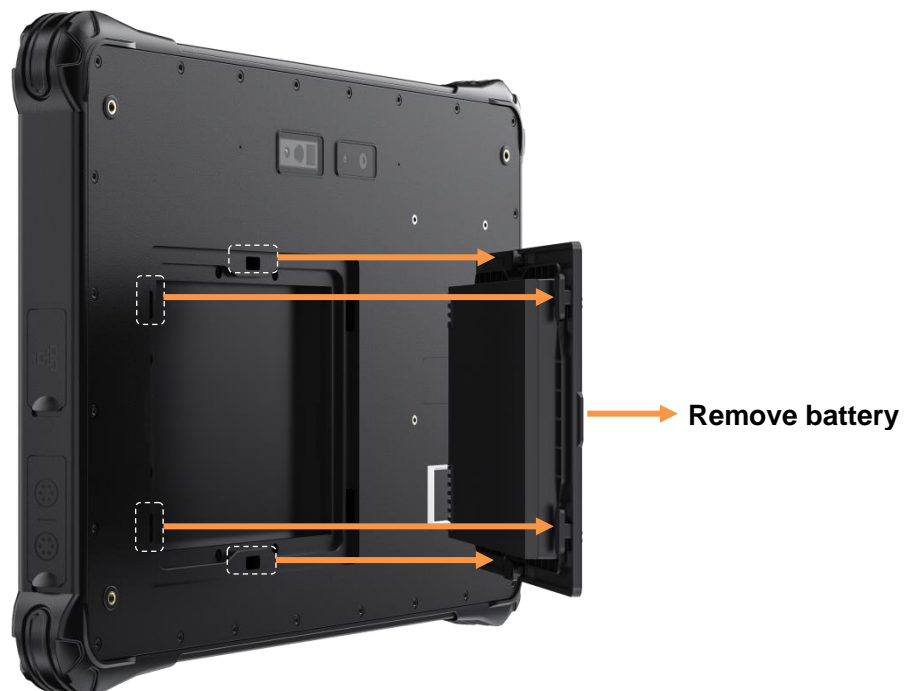

Chapter 6. Product Maintenance



6. Product Maintenance

6.1 Protective Tablet

To protect the data integrity of the tablet and the security of the tablet itself, you can protect the tablet in several ways described in this section.

- Use anti-virus measures
 - You can install antivirus software to protect your tablet.

6.2 Flat Maintenance

6.2.1 Environmental Standard

- To ensure optimum performance, use the tablet in the recommended temperature range of 0 °C to 40 °C. (Actual operating temperature depends on product specifications.)
- Avoid humidity, extreme temperatures, vibration, direct sunlight and places with a lot of dust when using the slab. Long-term use of tablets in extreme environments can lead to product degradation and shortened product life.
- Do not operate in an environment containing metal dust.
- The plate should be placed on a stable and firm surface. Do not store the tablet on its side or turn it upside down. A strong impact from a drop or blow may damage the tablet.
- Do not cover or block any vents on the tablet. For example, do not place the tablet on a bed, sofa, rug, or other similar surface. Otherwise, the tablet will be damaged due to overheating.
- The tablet will generate high temperatures during operation. Please keep the tablet away from items that are easily damaged by heat.
- The flat tablet should be at least 13cm away from electrical appliances that generate strong magnetic fields, such as televisions, refrigerators, motors, or large loudspeakers.
- Do not immediately move the tablet from cold to warm. If the temperature difference between the two places is higher than 10 ° C, it will condense water vapor inside the machine and damage the storage medium.

6.2.2 General criterion

- Do not place heavy objects on the tablet to avoid damaging the screen.
- To protect the LCD screen from damage, do not touch the screen with sharp objects.
- Leaving the LCD screen to display a fixed image for a long time may cause image residue. Limiting the length of time the screen displays static content can help avoid this problem. It is recommended that you use a screen saver or turn off the screen when not in use.
- To extend the life of the screen backlight, turn off the automatic backlight from the power management.

6.2.3 Clean-up criteria

- Do not clean the tablet during tablet startup.
- When cleaning the outside of the fuselage, wipe it with a soft cloth dampened with water or alcohol-free detergent.
- When cleaning the screen, wipe it with a soft cloth free of debris.
- If the plate gets wet with water or other liquids, dry it when you can. Although your tablet is waterproof, However , it is still not suitable for the tablet to remain wet while it can be wiped dry.
- Flat tablet wet at 0 °C may cause frostbite. Be sure to wipe the wet tablet dry.

6.2.4 Battery criteria

- Batteries are consumables, and the following conditions will shorten their service life:
 - Charge the battery frequently
 - Use, charge or store batteries in high temperature environments
- In order to avoid accelerating the aging of the battery and extending its service life, the number of charging times should be minimized to avoid the internal temperature rising frequently.
- Charge the battery in a temperature range of 10 °C to 30 °C. Higher ambient temperatures cause battery temperatures to rise. Avoid charging batteries in closed cars and in hot weather conditions.
- Do not charge the battery multiple times in one day.
- It is recommended that you charge the battery with the tablet off.
- If you need to remove the battery for storage, in order to maintain the operating efficiency of the battery, please remove it from the tablet when the remaining power is 30% to 40%, and then store it in a cool and dark place.
- Note the following when installing or removing batteries:
 - Do not touch the battery terminal. Otherwise, it may cause damage, which may cause the battery or tablet to work improperly.
- The input voltage and ambient temperature of the plate directly affect the charging and discharging time of the battery:

- The charging time is extended when the tablet is active.
- To shorten the charging time, it is recommended to put the tablet in sleep or hibernate mode.
- The low temperature will lengthen the charging time and shorten the discharge time.
- When battery power is used at extremely low temperatures, there may be shortened operating time and incorrect power display values. This is due to the chemistry of the battery.
- Do not store the battery for more than six months without charging it.

6.2.4 Touch screen criteria

- Use your finger or touch screen pen to operate on the touch screen. If sharp or metal objects are used, the display may be scratched and damaged, leading to errors.
- Use a soft cloth to wipe the dust off the display. The touch screen surface has a special protective layer to prevent dust from adsorbing on it. If a soft cloth is not used, the special protective layer on the touch screen surface may be damaged.
- Turn off the panel power before cleaning the display. Cleaning the display when it is turned on May cause abnormal operation.
- Avoid pushing too hard on the screen. Do not place items on the screen to avoid screen breakage and damage.
- In low and high temperature conditions, the touch screen response speed may be slow or the touch position may be offset. After reaching room temperature conditions, it can return to normal.

6.3 Carry it on long trips

- Make sure the battery is fully charged.
- Power supply should be turned off properly.
- All protective covers should be securely covered to ensure the waterproof performance of the tablet.
- Carry a tablet power adapter with you. Use a power adapter as a power supply with a battery charger.
- The tablet must be carried with you on the plane and never hauled in the suitcase.
- If you want to leave the tablet in the car, place it in the trunk to avoid overheating.
- When going through airport security, it is recommended that you take the tablet and disk to the X-ray machine (the machine where you put your carry-on luggage). Magnetic field detectors (including arched door machines you walk through and handheld detectors held by security personnel) should be avoided.
- When traveling overseas with a tablet, check the local national power cord specifications.

Chapter 7. FAQ and Warranty



7. FAQ & Warranty

7.1 Preliminary Inspection Items

• When you encounter a problem, you may wish to do the following preliminary checks, perhaps at this stage you can solve the problem:

- Try to identify the source and type of problem.
- Make sure you power on the peripheral before turning on the tablet.
- If there is a problem with the external device, make sure that all lines are properly and securely connected.
- Observe the actual situation. Does any information appear on the screen? How is the light on?

When you have to ask for help from maintenance personnel, the more detailed the information you provide, the better.

• If the problem persists after following the instructions in this chapter, contact your authorized distributor for assistance.

7.2 Reboot

- When the tablet crashes due to a problem, you may need to restart the tablet.
- If it is determined that the tablet has crashed and you cannot use the restart function provided by the operating system, restart it in one of the following ways:
 - Press and hold the power button for more than 5 seconds to force the tablet off. Then turn it on again.

7.3 Warranty and After-sales Service

• If the machine fails, contact your original retailer with the product name, serial number and details of the problem.



Darveen Co., Ltd.

Email: sales@darveen.com

www.darveen.com

Darveen Co., Ltd. All Rights Reserved